

PREMIUM CLASS

COACHBUILT 2022



c-tourer T | chic c-line T

carthago[®]
Das Reisemobil.

Table of contents

Carthago – More than just a company	3
The premium coachbuilt motorhome	8

LIGHTWEIGHT PREMIUM CLASS



c-tourer T Lightweight	10
The sophisticated all-rounder: practical lightweight models for the demands of the 3.5 t weight class, compact vehicle lengths	
Models	24
Technology	31
Standard equipment	36

COMFORT PREMIUM CLASS



c-tourer Comfort	10
The sophisticated all-rounder: comfort models outside of the 3.5 t weight class for fulfilling high comfort demands	
Models	24
Technology	31
Standard equipment	36



chic c-line T	38
The new fascination of the Carthago premium class: elegance, comfort and extravagance	
Models	44
Technology	52
Standard equipment	56

The Carthago worlds of living	58
The Carthago Premium DNA	62
Our powerful partners	80

Find out more on our website www.carthago.com



Additional information



Video available



Interactive panorama





Carthago – More than just a company

Dear motorhome enthusiasts,

More than 40 years of the Carthago Group also means more than 40 years of the premium concept, diversity and technical know-how.

Much has grown in more than 40 years: Our head office with production and a large sales exhibition in Aulendorf in Upper Swabia, and our plant in Odranci/Slovenia. The number of employees has also increased to more than 1500, we have more than 200 partners in Germany and abroad, and the diversity of our vehicles has expanded with numerous different models. However, one thing hasn't changed: Despite the use of state-of-the-art manufacturing methods, each Carthago has been manufactured with care and a considerable amount of craftsmanship and attention to detail for more than 40 years.

We have put our heart and soul into the development of the Carthago Group. The only people we are indebted to are you, our customers. This independence was confirmed with the establishment of the Carthago family foundation in 2014, and will remain so in the future.

You can put your trust in this as much as our employees do: the Carthago Group remains a dynamic family-run company with a great deal of motivation and passion, characterised by personal commitment.

In order to ensure that our premium claim will also continue for future decades, we implement ideas quickly, think innovatively and abide by our Carthago Premium DNA.

See for yourself: Visit us online, at exhibitions, at Carthago City or at one of our dealers. We look forward to seeing you!

Yours, Karl-Heinz Schuler

Founder, owner and foundation chairman

The Carthago Premium DNA

We find that only the best is good enough

Carthago has been an independent family-run company and permanent feature at the pinnacle of the motorhome industry for more than 40 years. Company founder and owner Karl-Heinz Schuler talks about what constitutes the Carthago premium DNA, why every Carthago motorhome is something very special and what unites the two at the same time.

Mr. Schuler, when did you decide to build motorhomes?

KARL-HEINZ SCHULER Panel Van Conversions caught my attention on many occasions whilst I was studying. I examined them more closely at the time, and something became clear to me in an instant: we can do better than that! The foundations for Carthago were laid with this idea and motivation.

Carthago has evolved into a premium manufacturer since 1979. Did you anticipate this success story at the time?

KARL-HEINZ SCHULER No-one could have known at the time that we would be so successful, nor could it have been planned. Our goal was always to build the best high-end motorhomes. We want to have satisfied customers. Success and growth then follow naturally.

What is the secret of your success?

KARL-HEINZ SCHULER The secret of our success is the Carthago inventive spirit. We are the leading innovator in the motorhome industry, we maintain our quality claim with every model series, and we are a pioneer within the industry time and time again. All of this is anchored in our Carthago premium DNA.

What does Carthago Premium DNA stand for?

KARL-HEINZ SCHULER Our Carthago premium DNA is our promise of value to our customers, it can be found in every one of our motorhomes and it is motivation and an obligation at the same time. It is characterised by the Carthago bodywork, the biggest storage space system in its class, the well thought-out heating and air conditioning technology, the highest payload reserves, our driving safety and visibility concept and the Carthago personality. We are simply exceptional: our materials, our jointing technology and the weight and stability demands are even similar to those of aircraft technology. We are quite rightly the European market leader for A-Class motorhomes in the price class of over € 85,000.* Because a Carthago is simply unmistakable!

How do Carthago drivers benefit from the premium DNA?

KARL-HEINZ SCHULER Our core expertise is in motorhomes in the Liner premium class. This is because our 40 years of experience in this area flow into every stage of development and manufacturing. We think that only the best is good enough for the comfort and safety of our customers! Not only do we provide maximum durability and value retention, safety, protection and comfort. It is just as important to us to implement every idea and every innovation in practice, and make everyday travelling as enjoyable as possible. And this applies to all of our vehicles – regardless of whether it is a 3.5 ton lightweight or a Liner class vehicle. In this way, each Carthago motorhome becomes something special, and therefore a synonym for exclusivity and quality. Or, to put it simply, Carthago stands for “The Motorhome”.



Long-lasting. High stability.

**Carthago Liner
premium-class
body construction**

Space guaranteed.

**Carthago double floor with
huge storage compartment**

* Evaluation based on the figures from the Caravaning Industrie Verbandes e.V. (Caravaning Industry Association)



***Carthago city in Aulendorf is the company headquarters.
What makes it special?***

KARL-HEINZ SCHULER The fact that any potential customer has the opportunity to experience the Carthago premium DNA for themselves! Because all potential customers are given a warm welcome at Carthago City. A tour of the factory will give you an insight into perfect craftsmanship,

combined with high-tech components and state-of-the-art manufacturing techniques. You can inspect the latest models at your leisure in our large showroom, arrange test drives and also rent motorhomes. It's worth making the trip to Aulendorf in Upper Swabia!

Well-being – all year round.

Carthago heating & air conditioning technology

Unique. Unmistakable.
Extravagant.

Carthago Personality

Well-balanced. Optimum distribution.

Carthago payload & weight and balance

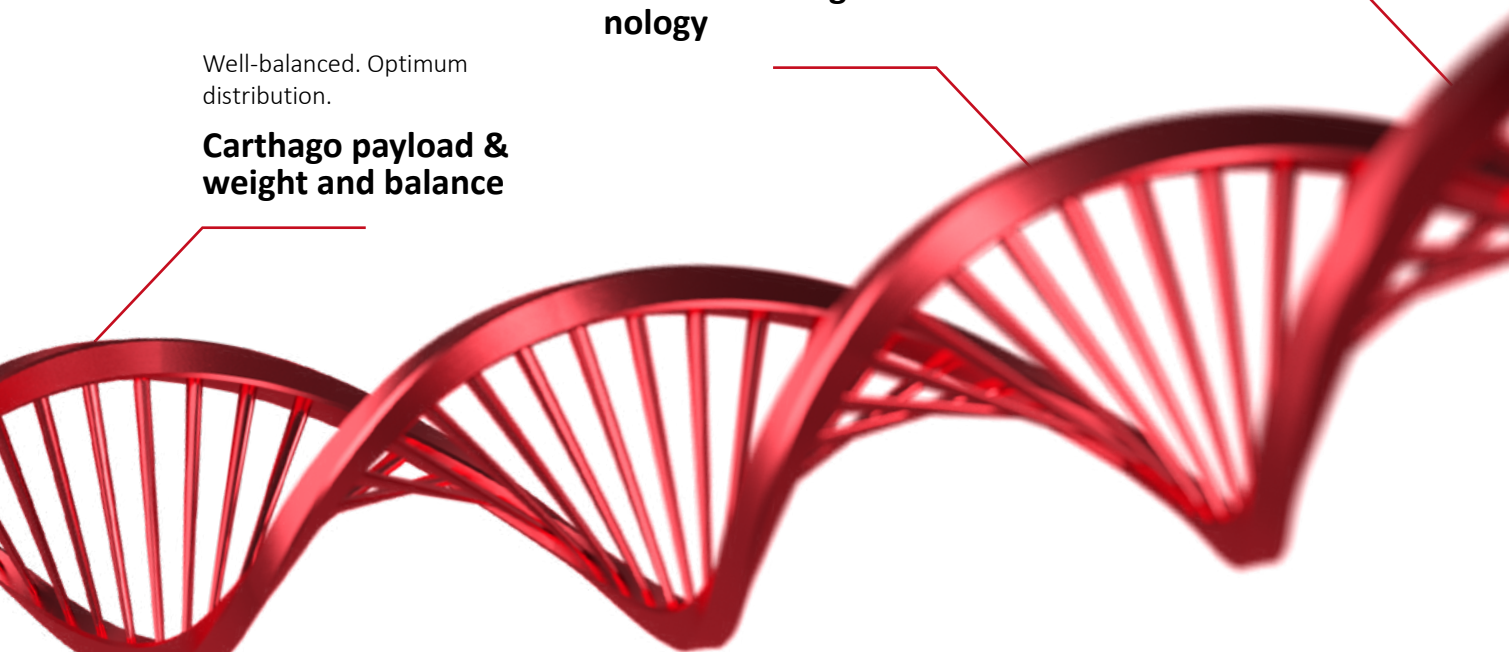



Carthago company headquarters in Aulendorf, Upper Swabia

Carthago City

Welcome

Down-to-earth and open minded at the same time, that is Carthago culture. We have remained true to our roots with the company headquarters in Carthago City in Aulendorf/ Upper Swabia, between Ulm and Lake Constance.

As well as the manufacturing facility for our premium class motorhomes, a large sales exhibition, the service centre for end customers and service partners and also the company headquarters are concentrated here.

Carthago is a popular destination for domestic and foreign motorhome enthusiasts. Visitors with a motorhome are welcome on the company's own pitch!

You can discover numerous models in our large sales exhibition during a visit – and the Carthago experts on site will be pleased to advise you.



The company's own pitch invites you to linger



Large sales exhibition in Carthago City



Convince yourself of the combination of perfect craftsmanship with high-tech components and state-of-the-art production methods on a factory tour. Overnight accommodation is available on the company's own pitch.

The Carthago premium motorhome deserves premium service. About 200 dealers and service partners throughout Europe look after you and your Carthago motorhome. Wherever you live, wherever you roam: Carthago is never far away! The initial contact is your local dealer, and a close-knit trade and service partner network is at your side throughout Europe during your travels.

All of our dealers and service partners are trained as certified Carthago Partners in a multi-level academy programme. However, exceptional situations don't stop at closing time. This is why Carthago has set up an emergency breakdown number which travellers can obtain technical assistance with problems, even at the weekend and during public holidays.

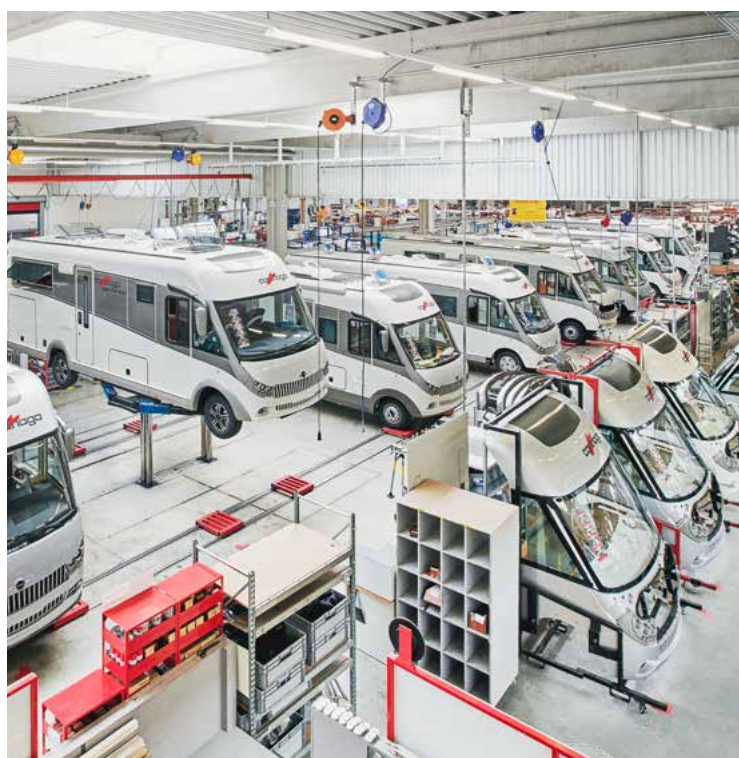

Take a look behind the scenes with a factory tour! Simply register your preferred date on our web site at www.carthago.com



The fascination of the premium coachbuilt

Dynamic and comfortable – simply Carthago

They are the coupés among motorhomes – flat, stylish and dynamic. The slender driver's cabin gives you a feeling of security and gives the motorhome great handling. The flat profile of the roof connection optimises the aerodynamics and gives coachbuilt motorhomes a bit of sportiness for the way.

An attractive side-effect: because of the original driver's cabin of your basic vehicle, the coachbuilt motorhomes are always somewhat more cost-effective than the elaborate A class motorhomes. The T-models therefore represent the entry level to the world of Carthago motorhomes.



Single level living area floor from rear to driver's cab



All-round overhead storage cabinets above driver's cab with ample storage space and indirect lighting



Optional central drop down bed Electrically operated, large sleeping area, headroom beneath the bed in living mode 184 cm



Driver's cab integration in living area, large L-shaped lounge seating area with side seat bench (picture shows optional skyview skylight)

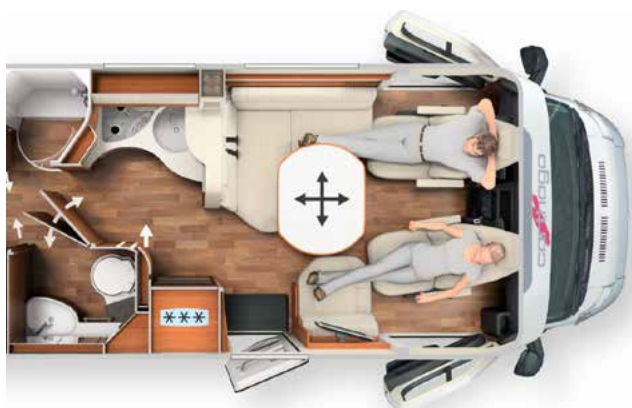

Relaxed TV viewing position: The driver's cabin seats can be rotated by 360°



Comfortable sitting position at living area table, all seats integrated



AL-KO



Mercedes-Benz

AL-KO

c-tourer

Lightweight / Comfort

The sophisticated all-rounder

Lightweight models with short vehicle lengths for the requirements of the 3.5 t weight class and comfort models with a gross weight of up to 4.5 t

A unique entry into the Carthago premium class: the c-tourer coachbuilt has all of the advantages of a Carthago with an amazingly attractive price-performance ratio. It is a lightweight among its contemporaries at the same time. The c-tourer model range provides both layouts for the 3.5t weight class (optionally also up to a gross weight of 4.5 t) and comfort models with a gross weight of up to 4.5 t.



c-tourer Lightweight

Models: T 142 DB, T 143 LE, T 144 LE, T 144 QB, T 145 DB H



- + All lightweight models with a practical payload, also in the 3.5t weight class, thanks to Carthago lightweight construction technology and short vehicle lengths of up to max. 7.10 m
- + Optionally also available with a gross weight of up to 4.5 t and therefore more payload



c-tourer Comfort

Models: T 148 LE H, T 148 LE, T 149 LE, T 150 QB

- + Comfort-oriented layouts over a vehicle length of 7.34 m
- + Considerable feeling of spaciousness and high payload reserves with a gross weight of up to 4.5 t



AL-KO



Mercedes-Benz
AL-KO

Chassis

- + Fiat Ducato 35 light/40 heavy or Mercedes-Benz Sprinter 414 CDI*, special Carthago AL-KO low frame with 198 cm wide wheelbase rear axle
- + Fiat Ducato safety package as standard: Airbag, ESP, ABS, ASR, , electronic immobiliser, Hillholder, Traction Plus, Hill Descent Control, automatic start/stop, cruise control, side wind assistant, trailer stability control, collision braking system / Mercedes-Benz Sprinter safety package as standard: Airbag, side wind assistant, Hillholder, ABS, ASR, EBV, ESP
- + Optional: Fiat driver's assistance package
- + XL main cabin door "premium two 2.0" with wider passage size of 63 cm, secure double locking and extra-wide door window



Living comfort

- + "Smartline plus" furniture design, two worlds of style
- + Single level living area floor
- + L-shaped lounge seating area with ergonomically designed upholstery and wide side seat bench
- + Comfort corner kitchen or corner kitchen* with six large drawers, raised kitchen worktop for visual room partitioning and as additional storage area
- + Different washroom solutions: maximum comfort with separable changing room*
- + Beds with extra-large sleeping dimensions



Storage space

- + Double floor with huge, heated storage compartment, usable height up to 55.5 cm
- + Exterior access via several large hatches, convenient access from the interior via the seat bench cover of the L-shaped lounge seating area and the swing-up side seat bench*
- + Large, central through-loading space (interior height 22 cm) with extra-low double floor storage compartment (usable height 46 cm) with large, self-supporting living area floor hatch
- + Scooter garage: interior height up to 120 cm*, loadable up to 350 kg



Self-sufficiency / equipment

- + 150 l fresh water, 140 l waste water
- + 1 x 80 Ah gel batteries (can be increased to 2 x 80 AH)



Air conditioning/heating

- + Truma Combi 6 warm air storage heating system, optional: Alde warm water heating*
- + Double floor with underfloor heating effect



Many c-tourer models also available on Mercedes-Benz Sprinter with AL-KO low frame chassis – see model overview and price list!

epic world of style as standard

Venezia 21 world of living (picture shows T 148 LE H)





c-tourer Lightweight

c-tourer Comfort

Optional Casablanca world of style

Barcelona 21 world of living (picture shows T 150 QB)





c-tourer Lightweight

c-tourer Comfort

Living area features

- + Living area table with chrome piping, can be rotated by 360° and moved in two directions using a foot pedal
- + Swivel-out shoe cabinet with holding system for up to four pairs of shoes integrated into the plinth of the seat bench, including LED mood light
- + Exclusive lighting concept with LED technology, main light with numerous spotlights and separately switchable indirect ambient light
- + Level passage from living room to driver's cabin without tripping hazards



Model T 143 LE

L-shaped lounge seating area with lift-up side seat bench

- + TV pull-out system above L-shaped lounge seating area for 24" LED flat screen or elegantly integrated designer TV cabinet for 32" LED flat screen (optional)
- + Easy storage compartment access without removing the upholstery via the seat bench cover of the L-shaped lounge seating area with patented fitting and lift-up side seat bench

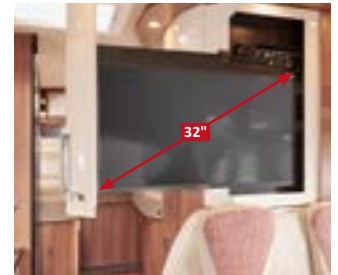

Elegantly integrated designer TV cabinet including 32" LED flat screen (optional)



Models T 144 LE, T 144 QB

L-shaped lounge seating area with lift-up side seat bench

- + TV wall bracket in entrance area for 24" LED flat screen (optional)
- + Easy storage compartment access without removing the upholstery via the seat bench cover of the L-shaped lounge seating area with patented fitting and lift-up side seat bench



TV wall bracket in entrance area (optional)



Models T 142 DB, T 148 LE, T 149 LE, T 150 QB

Large L-shaped lounge seating area with wide and swing-up seat bench, optional 5th belted seat

- + TV pull-out system "Quick up" behind side seat bench backrest for optional 24" LED flat screen
- + Easy storage compartment access without removing the upholstery via the seat bench cover of the L-shaped lounge seating area with patented fitting and lift-up seat bench



TV pull-out system behind side seat bench backrest (optional)

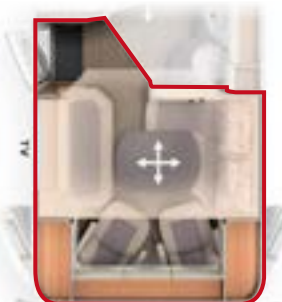

Models T 145 DB H, T 148 LE H

Large L-shaped seating area with long side sofa, optional 5th belted seat

- + TV pull-out system behind side seat bench backrest for optional 32" LED flat screen



TV pull-out system behind side seat bench backrest (optional)



L-shaped lounge seating area with wide side seat bench
(T 142 DB, T 148 LE, T 149 LE, T 150 QB)



Swivel-out shoe cabinet with holding system for up to four pairs of shoes integrated into the plinth of the seat bench



Living area table: can be conveniently rotated and moved using a foot pedal



They provide organisation and blend perfectly into the interior: the Carthago clothes hooks



c-tourer Lightweight T 143 LE in Casablanca world of style and Cambridge world of living, with optional "skyview" skylight

Kitchen highlights

- + "Profi Gourmet" 3-ring hob with divided glass cover (one piece in T 143 LE), with robust cast iron trivet and easy-clean glass base
- + Designer overhead storage compartment in vertical waveform
- + Optional: capsule coffee maker with pull-out system in overhead storage cabinet in vertical waveform
- + Sink cover embedded flush in the surface, can be used as additional work surface/chopping board
- + Raised kitchen worktop for visual room partitioning and as additional storage area



Model T 143 LE

Space-saving galley kitchen

- + Short vehicle length
- + 133 l Slimtower fridge with door opening at both sides and separate freezer compartment
- + Kitchen units with six large drawers and integrated waste bin



Optional: capsule coffee maker with pull-out system in overhead storage cabinet in vertical waveform



Models T 145 DB H, T 148 LE H

Corner kitchen

- + Large work surface
- + 153 l fridge with door opening at both sides and separate freezer compartment
- + Kitchen units with six large drawers and integrated waste bin (T 145 DB H) or separate waste bin in separate hygiene area (T 148 LE H)
- + Indirect ambient lighting in floor plinth



Large 153 l refrigerator at hand height



Models T 142 DB, T 144 LE, T 144 QB, T 148 LE

Corner kitchen

- + Large work surface
- + 133 l Slimtower refrigerator opposite with door opening at both sides and separate freezer compartment (T 144 LE, T 144 QB)
- + 153 l refrigerator opposite with door opening at both sides and separate freezer compartment (T 142 DB, T 148 LE)
- + Spice rack on the kitchen wall (T 142 DB, T 148 LE)
- + Kitchen units with six large drawers and integrated waste bin (T 144 LE/QB) or separate waste bin in separate hygiene area (T 142 DB, T 148 LE)
- + Indirect ambient lighting in floor plinth



Practical spice rack (T 142 DB, T 148 LE)

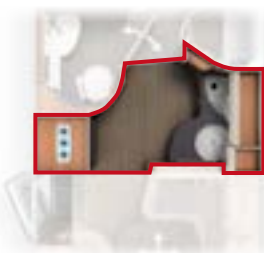

Models T 149 LE, T 150 QB

Comfort corner kitchen

- + Curved, extra large work surface, extended into the round washroom wall
- + 153 l refrigerator opposite with door opening at both sides and separate freezer compartment
- + Kitchen units with six large drawers and integrated waste bin (T 150 QB) or separate waste bin in separate hygiene area (T 149 LE)
- + Integrated bottle cabinet
- + Indirect ambient lighting in the floor plinth



Securely stowed away: practical bottle cabinet



Luxury corner kitchen in Casablanca world of style (T 149 LE, T 150 QB)



Space-saving galley kitchen in Casablanca world of style (T 143 LE)



Corner kitchen with spice rack in Casablanca world of style (T 142 DB, T 148 LE)



Six large drawers with separate waste bin in separate hygiene area (model-dependent)



Use of the sink cover via the wall holder with chopping board function

Washroom and changing room highlights

- + Different washroom concepts with practical convenience in as small a space as possible
- + Solid washroom door with internal hinges, metal handle and door lock
- + Shower room can be completely separated from washroom
- + Spacious wash stand base unit
- + Mini-Heki skylight in washroom
- + Numerous shelves



Combined washroom

- + Large, round shower that can be separated via a sliding door
- + Integrated shower shelf and towel rail in the Mini-Heki
- + Large mirror storage cabinet with shelving arrangement
- + Changing room separable from living area using washroom door with room dividing function (T 143 LE)

Models T 143 LE, T 145 DB H, T 148 LE H



Round shower



Combined washroom with separable changing room

- + Separable round shower
- + Integrated shower shelf and towel rail in the Mini-Heki
- + Large mirror storage cabinet with shelving arrangement
- + Changing room separable from living area via lockable washroom door, floor-to-ceiling wardrobe integrated in the changing room
- + Additional partitioning from sleeping area via solid wood sliding door (T 148 LE)

Models T 142 DB, T 148 LE



Changing room with room partitioning (T 148 LE)



Compact or comfort luxury washroom with changing room

- + Spacious washroom / toilet room with shower opposite
- + Waterproof shower insert in same design as living area floor, removable for showering (except T 149 LE)
- + Changing room separable from living area via sliding door (T 144 LE/QB)
- + Changing room separable from living area via lockable luxury washroom door and from sleeping area via solid wood sliding door (T 149 LE)
- + Changing room separable from living area via lockable luxury washroom door and from sleeping area via pull-out TV wall and room divider (T 150 QB)

Compact luxury washroom
Models T 144 LE, T 144 QB



Comfort luxury washroom
Models T 149 LE, T 150 QB



Combined washroom: Washroom / toilet area with separate round shower
(T 142 DB, T 148 LE)



Washroom with washbasin and toilet (T 144 LE, T 144 QB)



Comfort luxury washroom with changing room separable from living area via lockable luxury washroom door and from sleeping area via solid wood sliding door (T 149 LE)

Sleeping area highlights

- + Extra-large sleeping area, 7-zone quality cold foam mattress with breathable climate quilting
- + Two-part heated and ventilated slatted frame with flexibly supported wooden slats

- + Optional: world of sleeping and decoration set with made-to-measure elasticated covers



Models T 142 DB, T 145 DB H

Transverse double bed

- + Bed access via large access steps
- + Large wardrobe beneath the bed
- + Room-high wardrobe



Wardrobe beneath transverse double bed (T 145 DB H)



Models T 143 LE, T 148 LE, T 148 LE H, T 149 LE

Lengthways single beds

- + Adjustable head sections (drivers side only in T 144 LE), sleeping area extension between the beds with additional mattress
- + Sleeping area at passengers side: 200 cm in sleeping position, large shower room is created when pushed back (T 144 LE)
- + Wardrobes beneath the lengthways single beds, conveniently accessible from front and above via lift function and divided mattresses (T 144 LE drivers side only, T 148 LE/T 148 LE H passengers side only)
- + Pull-out access steps for accessing the bed (T 143 LE)
- + Pull-out comfort access steps with extra-deep treads and additional storage compartment (T 148 LE, 148 LE H, 149 LE; optional with T 143 LE)

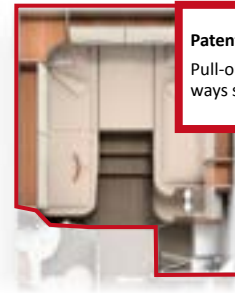

Patented⁽¹⁾: Pull-out lengthways single beds

Model T 144 LE with bed at the passenger side which can be moved by up to 30 cm



Model T 144 QB

Queen-size bed

- + Sleeping area can be moved by 30 cm for comfortable living and sleeping configuration with a short vehicle length. Convenient access to wardrobes in sleeping configuration: sleeping length 195 cm (T 144 QB)
- + Adjustable head section
- + Wardrobes on the left and right of the queen-size bed
- + Large drawer in the front of the queen-size bed
- + Fold-away mattress at driver side for extra-wide passage (T 150 QB)
- + Unique: Pull-out TV wall and room divider for separating off the washroom area (T 150 QB)



Model T 150 QB



Optional: TV cabinet for lengthways single bed models (except T 144 LE)

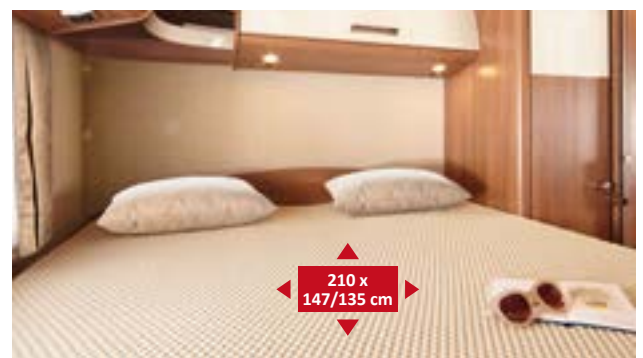

Large transverse double bed with all-round overhead storage cabinets (T 142 DB)



Large lengthways single beds with raisable head section and access steps. Convenient access to wardrobes below from front and above thanks to lift function (T 143 LE, T 148 LE, T 148 LE H, T 149 LE)

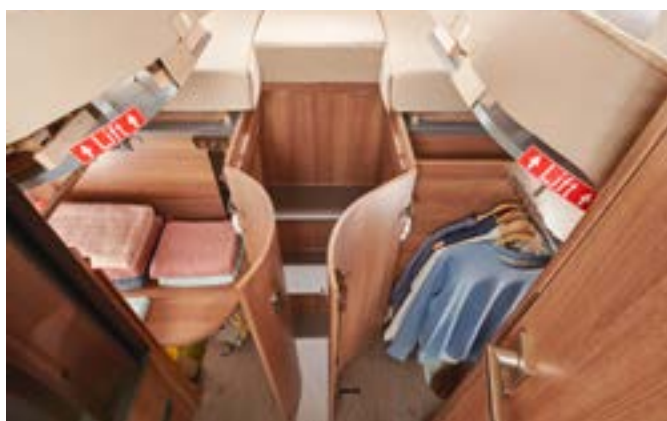

Wardrobes beneath the lengthways single beds, conveniently accessible from front and above via the lift function (depending on model)



Pull-out single bed with access steps (T 144 LE)



Sleeping area can be moved by 30 cm for comfortable living and sleeping configuration within a short vehicle length (T 144 QB)

c-tourer Lightweight T 142 DB



AL-KO



Registered for patent approval⁽¹⁾:
Changing room with room dividing function

c-tourer Lightweight T 143 LE



AL-KO



Mercedes-Benz
AL-KO



c-tourer Lightweight T 144 LE



AL-KO



Patented⁽¹⁾:
Pull-out lengthways single bed

MODEL HIGHLIGHTS

- + Short vehicle length specifically for the 3.5 t weight class, L-shaped lounge seating area with swing-up side seat bench, large transverse double bed
- + Corner kitchen with large work surface and indirect ambient lighting in the floor plinth
- + Raised kitchen worktop for visual room partitioning and as additional storage area
- + Separation from living area as changing room via the room dividing function of the washroom door
- + Combined washroom with round shower and practical towel rail in the Mini-Heki
- + Room-high wardrobe
- + Additional wardrobe beneath transverse double bed

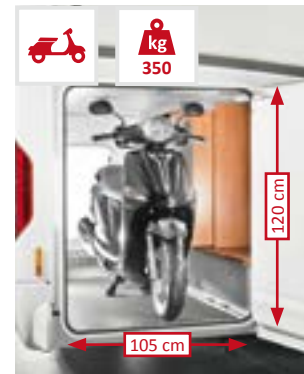

Chassis	Weight ready to drive	Payload up to	Seats with three-point seat belt	Berths
Fiat Ducato AL-KO Low frame 35 light	2,915 kg	1,545 kg	4/5*	2/4*

- + All-rounder: lots of comfort, short vehicle length, light weight
- + L-shaped lounge seating area with lift-up side seat bench
- + Compact galley kitchen
- + Raised kitchen worktop for visual room partitioning and as additional storage area
- + Combined washroom with round shower and practical towel rail in the Mini-Heki
- + Changing room separable by washroom door
- + Wardrobes beneath lengthways single beds with extra-large interior height due to lowering into the double floor
- + Pull out steps for easy access to bed, optional pull-out comfort access steps with extra-deep treads and additional storage compartment
- + Optional: TV cabinet in sleeping area with special TV pull-out system

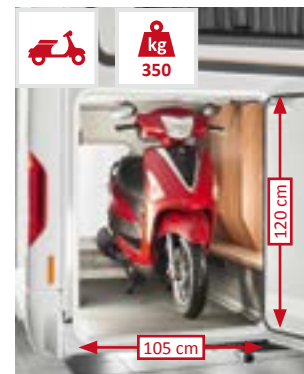

Chassis	Weight ready to drive	Payload up to	Seats with three-point seat belt	Berths
Fiat Ducato AL-KO Low frame 35 light	2,915 kg	1,545 kg	4	2/3*
Mercedes-Benz Sprinter AL-KO Low frame	2,995 kg	1,475 kg	4	2/3*

- + Unique: L-shaped lounge seating area, lift-up side seat bench, corner kitchen, luxury washroom and lengthways single beds up to 200 cm long with a vehicle length of just under 7 m
- + Corner kitchen with large work surface and indirect ambient lighting in the floor plinth
- + Raised kitchen worktop for visual room partitioning and as additional storage area
- + Changing room can be separated from living room via solid wooden sliding door
- + Compact luxury washroom with separate shower
- + Lengthways single bed at passenger side, movable by 30 cm: 200 cm sleeping length in sleeping mode / spacious shower room in living mode
- + Access steps for easy access to bed
- + Wardrobes beneath lengthways single beds with extra-large interior height due to lowering into the double floor

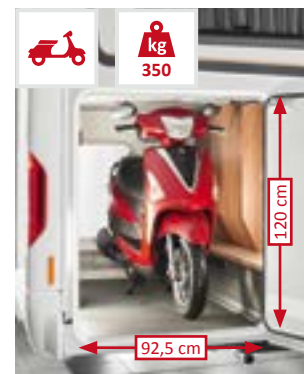

Chassis	Weight ready to drive	Payload up to	Seats with three-point seat belt	Berths
Fiat Ducato AL-KO Low frame 35 light	2,975 kg	1,485 kg	4	2/4*

c-tourer Lightweight/Comfort

Models

c-tourer Lightweight T 144 QB



AL-KO

3.5 t ✓

4.5 t ✓



Patented⁽¹⁾:
Pedelec scooter
garage



c-tourer Lightweight T 145 DB H



AL-KO

3.5 t ✓

4.5 t ✓



c-tourer Comfort T 148 LE H



AL-KO



Mercedes-Benz
AL-KO

3.5 t ✓

4.5 t ✓



Patented⁽¹⁾:
Pull-out comfort
access steps



MODEL HIGHLIGHTS

- + Unique: L-shaped lounge seating area, side seat bench, corner kitchen, luxury washroom and 195 cm queen-size bed with a vehicle length of just under 7 m
- + Corner kitchen with large work surface and indirect ambient lighting in the floor plinth
- + Raised kitchen worktop for visual room partitioning and as additional storage area
- + Changing room can be separated from living room via solid wooden sliding door
- + Compact luxury washroom with separate shower
- + Queen-size bed can be moved by 30 cm: 195 cm sleeping length in sleeping configuration / spacious access to the wardrobes in living configuration, comfortable sleeping width as far as the foot area
- + Two wardrobes at each side of the queen-size bed
- + Large drawer at front of queen-size bed



Chassis	Weight ready to drive	Payload up to	Seats with three-point seat belt	Berths
Fiat Ducato AL-KO Low frame 35 light	2,975 kg	1,485 kg	4	2/4*

- + Short vehicle length specifically for the 3.5 t weight class with L-shaped lounge seating area and long side seat bench, large transverse double bed
- + Optional: Central drop-down bed with wide sleeping area for two persons
- + Corner kitchen with large work surface and indirect ambient lighting in the floor plinth
- + Raised kitchen worktop for visual room partitioning and as additional storage area
- + Combined washroom with separable round shower
- + Room-high wardrobe
- + Additional wardrobe beneath transverse double bed

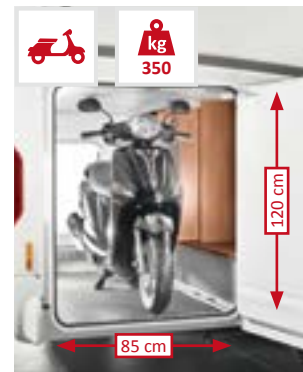

Chassis	Weight ready to drive	Payload up to	Seats with three-point seat belt	Berths
Fiat Ducato AL-KO Low frame 35 light	2,945 kg	1,515 kg	4/5*	2/5*

- + Comfort-oriented layout: Large L-shaped lounge seating area, wide side seat bench, corner kitchen, floor-to-ceiling high wardrobe
- + Optional: Central drop-down bed with wide sleeping area for two persons
- + Corner kitchen with large work surface and indirect ambient lighting in the floor plinth
- + Raised kitchen worktop for visual room partitioning and as additional storage area
- + Combined washroom with separable round shower
- + Wardrobe with extra large interior height beneath the lengthways single beds
- + Optional: TV cabinet in sleeping area with special TV pull-out system
- + Lengthways single beds up to 200 cm long with pull-out comfort access steps with extra deep treads and additional storage compartment

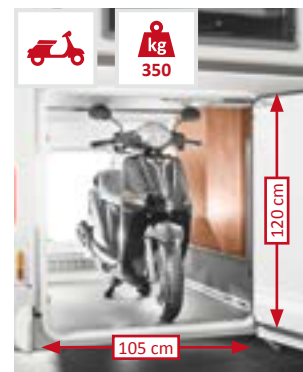

Chassis	Weight ready to drive	Payload up to	Seats with three-point seat belt	Berths
Fiat Ducato AL-KO Low frame 35 light	3,015 kg	1,445 kg	4/5*	2/5*
Mercedes-Benz Sprinter AL-KO Low frame	3,095 kg	1,375 kg	4/5*	2/5*

c-tourer Lightweight/Comfort

Models

c-tourer Comfort T 148 LE



AL-KO

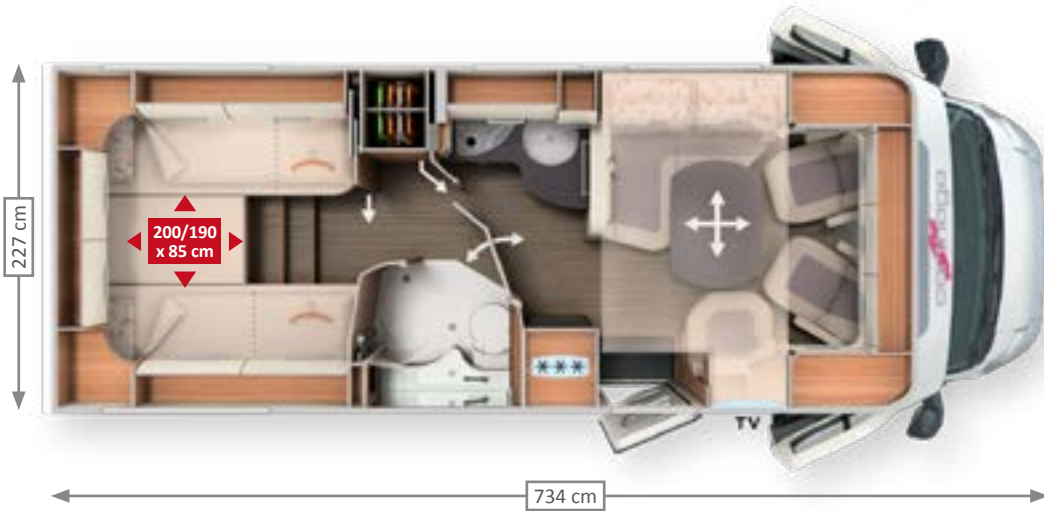

Patented⁽¹⁾:
Pull-out comfort access steps

Registered for patent approval⁽¹⁾:
Changing room with room dividing function

c-tourer Comfort T 149 LE



AL-KO

Mercedes-Benz
AL-KO

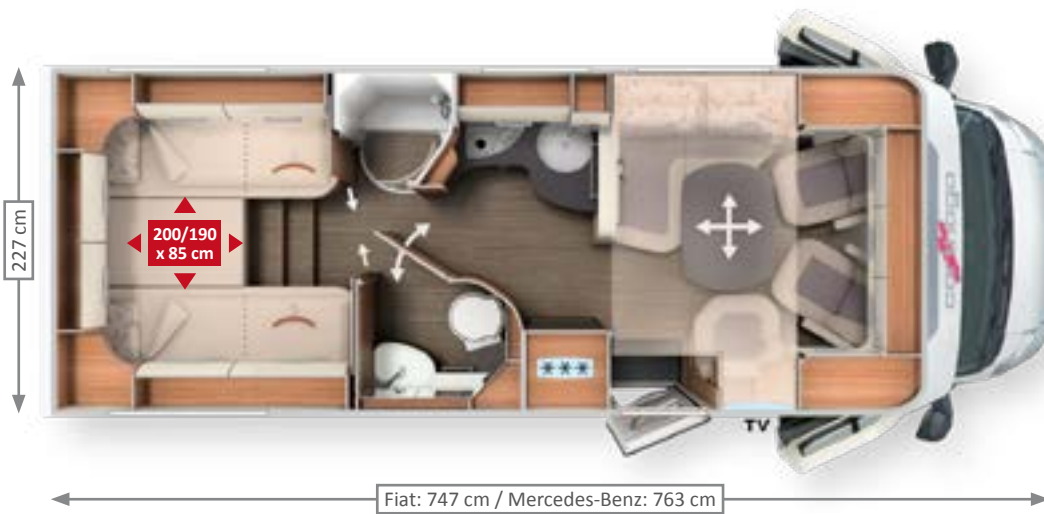

Patented⁽¹⁾:
Pull-out comfort access steps

c-tourer Comfort T 150 QB



AL-KO

Mercedes-Benz
AL-KO



Patented⁽¹⁾:
Pedelec scooter garage

Registered for patent approval⁽¹⁾:
Pull-out TV wall and room divider

MODEL HIGHLIGHTS

- + Comfort-oriented layout: Large L-shaped seating area with wide, swing-up side seat bench, room high wardrobe
- + Corner kitchen with large work surface and indirect ambient lighting in the floor plinth
- + Raised kitchen worktop for visual room partitioning and as additional storage area
- + Combined washroom with round shower, washroom door with room dividing function and practical towel rail in the Mini-Heki
- + Changing room separable from living area via lockable luxury washroom door and from sleeping area via sliding door made from solid wood
- + Room-height wardrobe, additional wardrobes with extra-large interior height beneath the lengthways single beds
- + Lengthways single beds up to 200 cm long with pull-out comfort access steps with extra-deep treads and additional storage compartment
- + Optional: TV cabinet in sleeping area with special TV pull-out system

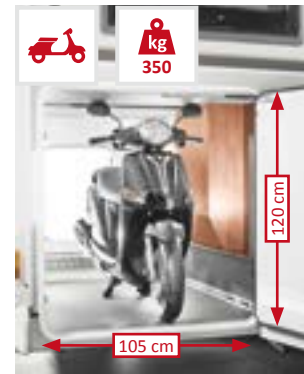

Chassis	Weight ready to drive	Payload up to	Seats with three-point seat belt	Berths
Fiat Ducato AL-KO Low frame 35 light	3,015 kg	1,445 kg	4/5*	2/4*

- + Comfort-oriented layout: large L-shaped lounge seating area with wide, swing-up side seat bench
- + Comfort corner kitchen with curved work surface and indirect ambient lighting in the floor plinth
- + Raised kitchen worktop for visual room partitioning and as additional storage area
- + Changing room separable from living area via lockable luxury washroom door and from sleeping area via sliding door made from solid wood
- + Lengthways single beds 200 cm long with pull-out comfort access steps with extra deep treads and additional storage space
- + Wardrobes beneath the lengthways single beds with large interior height
- + Optional: TV cabinet in sleeping area with special TV pull-out system

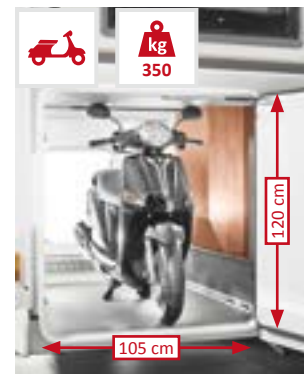

Chassis	Weight ready to drive	Payload up to	Seats with three-point seat belt	Berths
Fiat Ducato AL-KO Low frame 35 light	3,015 kg	1,445 kg	4/5*	2/4*
Mercedes-Benz Sprinter AL-KO Low frame	3,095 kg	1,375 kg	4/5*	2/4*

- + Comfort-oriented layout: large L-shaped lounge seating area with wide, swing-up side seat bench
- + Comfort corner kitchen with curved work surface and indirect ambient lighting in the floor plinth
- + Raised kitchen worktop for visual room partitioning and as additional storage area
- + Changing room separable from living area via lockable luxury washroom door and from sleeping area via pull-out TV wall and room divider
- + Large queen-size bed, convenient bed access, comfortable sleeping width as far as the foot area
- + Two wardrobes at each side of the bed
- + Two large drawers at the front of the queen-size bed
- + Fold-away mattress section at driver side for extra-wide passage



Chassis	Weight ready to drive	Payload up to	Seats with three-point seat belt	Berths
Fiat Ducato AL-KO Low frame 35 light	3,015 kg	1,445 kg	4/5*	2/4*
Mercedes-Benz Sprinter AL-KO Low frame	3,095 kg	1,375 kg	4/5*	2/4*

c-tourer Lightweight/Comfort

Exterior



Standard white

Main cabin, vehicle front, front, side and rear skirting and wheel arches in white

Fiat Ducato



Mercedes-Benz Sprinter



Right reserved to differences in the colour scheme or individual colour shades, differences in material characteristics and changes to the scope of delivery on the part of the manufacturer. This also applies to colour differences on basic vehicles, insofar as they are a result of changes made by the basic vehicle manufacturer.

Driver's cabin design

c-tourer Comfort T 150 QB on Fiat Ducato with San Remo world of living



c-tourer Lightweight T 143 LE on Mercedes-Benz Sprinter with Cambridge world of living



Carthago lightweight construction technology

“Lightweight”

Down with the weight, up with the quality – specially for the 3.5 t weight class

Extremely stable and super light: Carthago is the pioneer for intelligent lightweight construction throughout the industry. Carthago reduces the weight, but not the customary comfort or quality. The Carthago c-tourer Lightweight vehicles are the lightest models

in their class. With maximum stability, quality, maximum comfort and a comprehensive range of equipment. The consistent lightweight construction technology has many benefits: more payload, lower fuel consumption and fewer emissions at the same time.

Your added value

- + **Outstanding manoeuvrability and less weight** due to short vehicle lengths
- + **More payload** also in the 3.5 t weight class
- + **Lower fuel consumption**
- + **Class B driver's license is sufficient**
- + **Fewer restrictions** because of road traffic regulations
- + **Fewer toll charges**

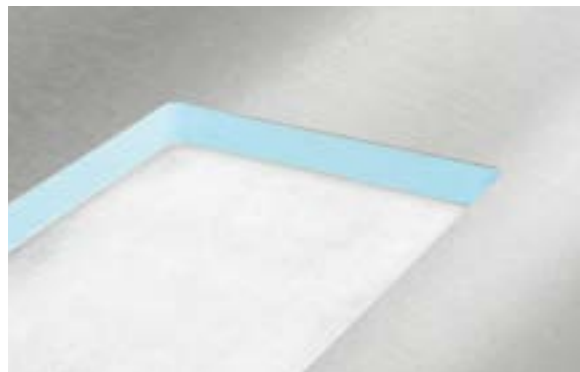

The Carthago main body construction technology is extremely stable and lightweight. The combination of aluminium on the outside and the inside and the RTM hard foam insulating core which are typical of the brand allows Carthago to dispense with weight-intensive wall reinforcements



Lightweight premium class
Carthago lightweight construction technology, especially for the 3.5 t weight class



Carthago weight-optimised furniture construction: thanks to the piping technology, the curved and rounded moulded furniture parts have high stability and less weight at the same time



With the self-supporting main body and the light AL-KO low frame, the Carthago double floor contributes to providing maximum stability and torsional rigidity



Usable height up to 55.5 cm

Double floor with huge storage compartment

EASY ENTRY – convenient loading from the outside, easy removal from the inside



PASSENGER SIDE

Gas bottle compartment



Convenient loading of the double floor storage compartment via a large external hatch (at the passenger side)



Easy removal of storage compartment contents from the inside via the lift-up seat bench cover of the L-shaped lounge seating area



Living area floor hatch with double floor storage box (42 cm usable depth) in heated double floor

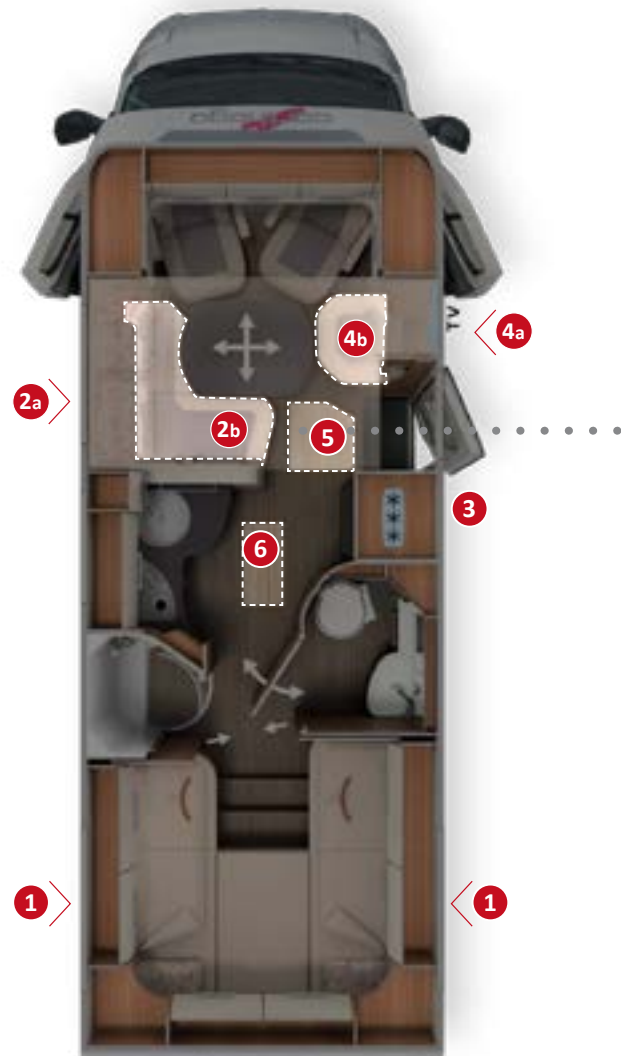



Your added value

- + **Double floor** with huge, heated storage compartment, usable height up to **55.5 cm**
- + **Exterior access** via several large hatches
- + Convenient **interior access** via L-shaped lounge seating area seat bench cover, lift-up (T 143 LE, 144 LE/QB) or swing-up (T 142 DB, 145 DB H, 148 LE, 148 LE H 149 LE, 150 QB) side seat bench and large living area floor hatch
- + **Large, central through-loading space** (interior height 22 cm), with extra-low double floor storage compartment (usable height 46 cm), convenient loading through the main cabin door via a large, self-supporting living area floor hatch
- + The entire double floor is heated with a **climate storage function** and underfloor heating effect



DRIVER'S SIDE



Large, additional double floor storage compartment with separate exterior hatch (driver's side)



Convenient loading of the double floor storage compartment via a large external hatch (depending on model)

Load from the outside



Huge living area floor hatch in the entrance area: easy to load from the outside when main cabin door is open





Convenient removal of contents via lift-up side seat bench (depending on model)

Unload from the inside

On-board equipment

Electrical equipment, water supply, warm air storage heating technology







Warm air storage heating technology
Truma Combi 6



**Optional:
Alde warm water heating**
(model-dependent)



Double floor
with climate storage function and underfloor heating effect



Capacity
150 l fresh water tank
140 l waste water tank
1 x 80 Ah gel battery
(can be increased to 2 x 80 Ah)



Truma Combi 6 warm air storage heating system with numerous warm air outlets in the entire double floor, the living area, the scooter garage, the driver's cabin and the cold-sensitive door entrances



"easy change" gas bottle compartment, extra-low for convenient bottle changing (except T 143 LE)

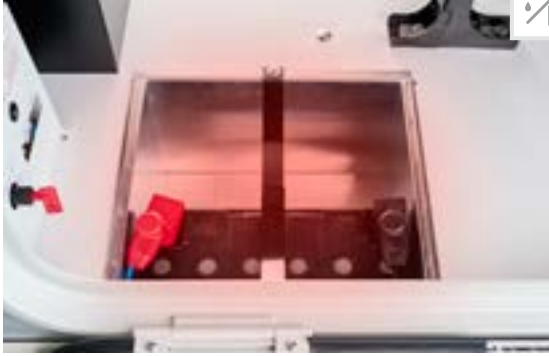

Heated battery centre with main battery switch; Standard: Gel batteries 1 x 80 Ah, extendible to 2 x 80 Ah, optional 90 Ah lithium-ion battery including battery computer and separate touch display



Easily accessible electric centre in the scooter garage

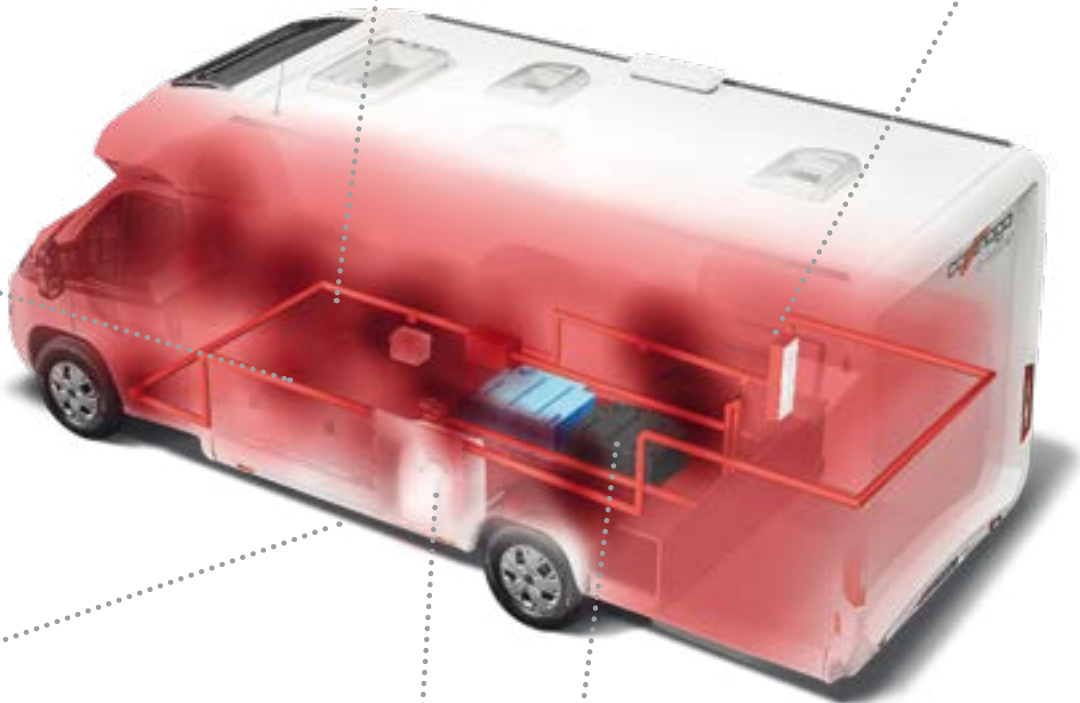

Gas bottle compartment with separate exterior door (T 143 LE). Optional: comfort gas bottle pull-out system



Central water drain in the double floor – can also be operated from the outside through the main cabin door

AL-KO low frame special light



Light weight, driving comfort comparable to a passenger car, fully galvanized

XL main cabin door "premium two 2.0"



With widened passage size of 63 cm, secure double locking, extra-wide door window, pleated blackout blind and integrated insect screen roller blind

Central locking



Using hand transmitter in the main key for the driver's cabin doors

Driver's cabin pilot seats



with upholstered, adjustable armrests

Electric entrance step



To living area: extracted / retracted electrically

All-round overhead storage cabinets



Provides a tremendous amount of storage space in the driver's cabin area

Overhead storage cabinet as standard



With optional coffee machine pull-out system

Ambient floor plinth underlighting



In living and kitchen area (model-dependent)

Spice rack



Design element and practical detail at the same time – secure storage for spices in the kitchen area (T 142 DB, T 148 LE)

Living area on one level



Continuous from driver's cabin to the sleeping area

Exclusive lighting concept in LED lighting technology



Main light with numerous spotlights and indirect ambient light, separately controllable

Ergonomically shaped seat upholstery



With multi-layer premium foam core and stylish front panel



AL-KO

chic c-line

new generation 2022

The new fascination of the Carthago premium class

Elegance, comfort and extravagance

Luxurious, extravagant, comfortable and thoroughly practical: The chic c-line coachbuilt comes up trumps with regard to payload, storage space, top class driving comfort, modern design and pure living comfort. Its charm sets the chic c-line coachbuilt apart from the wide range of coachbuilt vehicles that are available on the market.



Weight class

- + Comfort-oriented floor plans up to a permissible gross vehicle weight of 4.5 t



AL-KO

Chassis

- + Fiat Ducato 35 light/40 heavy with AL-KO low frame, wide wheelbase rear axle, 198 cm
- + Standard Fiat Ducato safety package: Airbag, ABS, ESP, ASR, electronic immobiliser, Hillholder, Traction Plus, Hill Descent Control, automatic stop/start, cruise control, stability control for towing, collision braking system, side wind assistant
- + Optional: Fiat driver's assistance package
- + XL habitation door "premium two 2.0" with wider passage size of 63 cm, secure double locking and extra-wide door window



Living comfort

- + "Exclusiveline" furniture architecture, flowing stylistic features, rounded, exclusive furniture finishes, three worlds of style to choose from
- + L-shaped lounge seating area with wide side seat bench and rectangular living area table with chrome piping
- + Comfortable corner kitchen with six large drawers, raised kitchen work surface with designer bar cabinet as visual room divider and additional work area
- + Washroom variants with outstanding comfort and separate changing room
- + Fixed beds with Carawinx sleeping system



Storage space

- + Double floor with huge, heated storage compartment, usable height up to 70 cm
- + Exterior access via several large hatches, convenient access from the interior via the seat bench cover of the L-shaped lounge seating area and the lift-up side seat bench
- + Large, central through-loading space (interior height 22 cm), with extra-low double floor storage compartment (usable height 46 cm), convenient loading from the inside and outside via a large, self-supporting living area floor hatch
- + Scooter garage: interior height up to 120 cm*, loadable up to 350 kg



Self-sufficiency / equipment

- + 170 l fresh water / 140 l waste water
- + 2 x 80 Ah gel battery



Air conditioning/heating

- + Truma Combi 6 warm air storage heating system, optional Alde warm water heating
- + Double floor with underfloor heating effect



linea moderna world of style as standard

Ivory 21 part leather world of living (picture shows T 4.9 LE)





Optional linea progressiva world of style

Macchiato part leather world of living (picture shows I 4.9 LE)





chic c-line T 4.8 LE



Patented⁽¹⁾:
Pull-out comfort access steps
Registered for patent approval⁽¹⁾:
Changing room with room dividing function



Large L-shaped lounge seating area with wide side seat bench

- + Rectangular living area table with chrome piping
- + TV pull-out system for 24" LED flat screen behind side seat bench backrest (optional)
- + Swivel-out shoe cabinet with holder system for up to four pairs of shoes integrated in plinth of seat bench



Corner kitchen

- + Raised kitchen work surface with designer bar cabinet as visual room divider and additional work surface
- + Six large drawers and separate waste container in separate hygiene area
- + "Profi Gourmet" 3-ring hob with divided glass cover, robust cast iron trivet and easy-clean glass base
- + 153 l fridge with door opening at both sides and separate freezer compartment
- + Pull-out system for capsule coffee maker at side of designer bar cabinet for convenient access (optional)
- + Room-high slide-out storage cabinet



Space-saving combined washroom with changing room

- + Separate round shower
- + Integrated shelf in shower wall, towel rail in Mini-Heki
- + Spacious mirror and wash stand base unit
- + Solid washroom door with internal hinges, metal handle and door lock

- + Changing room separable from living and sleeping area via solid wooden sliding doors, swivelling washroom door and pull-out room dividing wall, wardrobe integrated in changing room



Large lengthways single beds

- + Adjustable head sections
- + Wardrobes beneath the lengthways single beds, easily accessible from front and above at the passengers side via the lift function – lowered into the double floor for additional interior height
- + Sleeping area extension between the beds using additional mattress, access via pull-out comfort access steps
- + Designer shelves in sleeping compartment
- + TV cabinet with special TV pull-out system (optional)

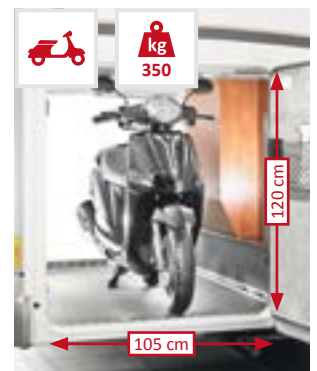

Chassis	Weight ready to drive	Payload up to	Seats with three-point seat belt	Berths
Fiat Ducato AL-KO Low frame 35 light	3,165 kg	1,595 kg	4/5*	2/3*

*with options



Corner kitchen with "Profi Gourmet" 3-ring hob in linea classica world of style with raised kitchen work surface with designer bar cabinet as visual room divider and additional work area



Room-height wardrobe



Combined washroom with spacious washroom and separable round shower



Combined washroom with changing room function



Large lengthways single beds with pull-out comfort access steps

chic c-line T 4.9 LE

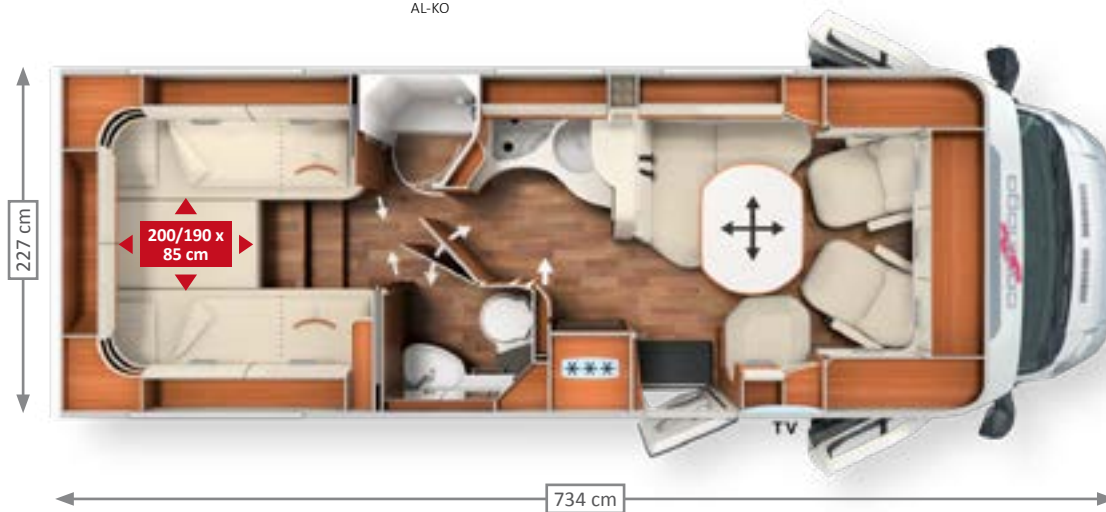

Patented⁽¹⁾:
 Double function door washroom / toilet room;
 Pull-out comfort access steps



Large L-shaped lounge seating area with wide side seat bench

- + Rectangular living area table with chrome piping
- + TV pull-out system for 24" LED flat screen behind side seat bench backrest (optional)
- + Swivel-out shoe cabinet with holder system for up to four pairs of shoes integrated in plinth of seat bench



Lengthways single beds

- + Adjustable head sections
- + Wardrobes beneath the lengthways single beds, easily accessible from front and above via the lift function – lowered into the double floor for additional interior height
- + Sleeping area extension between the beds using additional mattress, access via pull-out comfort access steps
- + Designer shelves in sleeping compartment
- + TV cabinet with special TV pull-out system (optional)



Comfort corner kitchen

- + Raised kitchen work surface with designer bar cabinet as visual room divider and additional work surface
- + Six large drawers and separate waste container in separate hygiene area
- + "Profi Gourmet" 3-ring hob with divided glass cover, robust cast iron trivet and easy-clean glass base
- + 153 l fridge with door opening at both sides and separate freezer compartment
- + Pull-out system for capsule coffee maker at side of designer bar cabinet for convenient access (optional)
- + Slide-out storage cabinet integrated in round wash-room wall



Comfort luxury washroom with changing room

- + Large washroom/toilet room
- + Shower opposite
- + Changing room separable from living, sleeping and toilet area via luxury washroom door with 3-way function thanks to washroom double door and solid wooden sliding doors

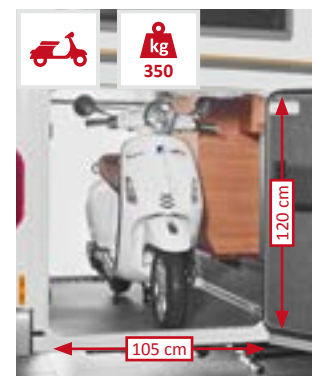

Chassis	Weight ready to drive	Payload up to	Seats with three-point seat belt	Berths
Fiat Ducato AL-KO Low frame 35 light	3,165 kg	1,595 kg	4/5*	2/3*

*with options



chic c-line T 4.9 LE in linea moderna world of style, ivory part-leather world of living with optional "skyview" skylight with designer roof lining above driver's cabin



TV pull-out system behind backrest



Comfort corner kitchen with raised kitchen work surface with designer bar cabinet as visual room divider and additional work surface



Wardrobes beneath the lengthways single beds with extra-large interior height



Luxury washroom with separate shower



Large lengthways single beds with pull-out comfort access steps

chic c-line T 5.0 QB

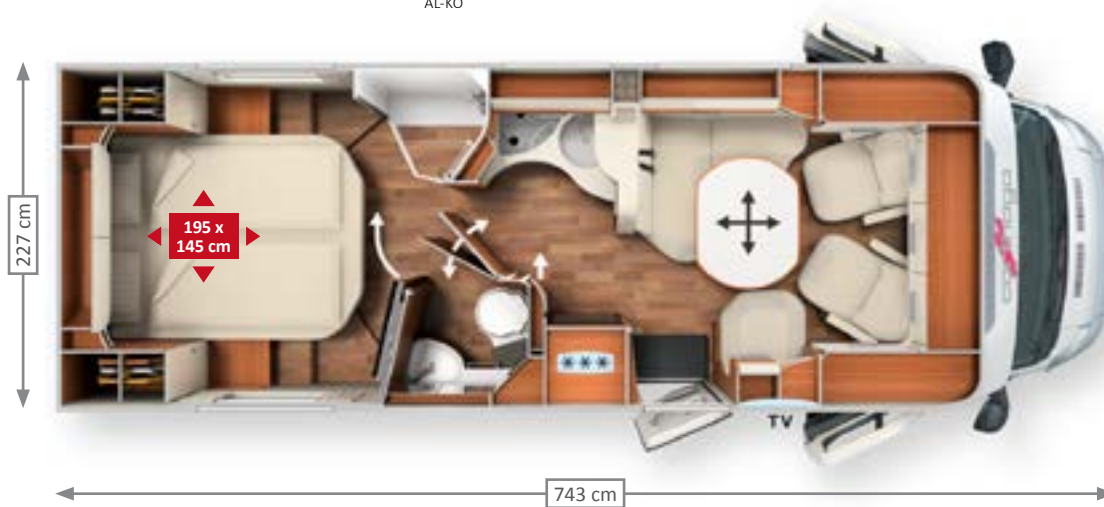

Patented⁽¹⁾:
 Double function door washroom / toilet room;
 Pedelec garage

Registered for patent approval⁽¹⁾:
 Pull-out TV wall and room divider



Large L-shaped lounge seating area with wide side seat bench

- + Rectangular living area table with chrome piping
- + TV pull-out system for 24" LED flat screen behind side seat bench backrest (optional)
- + Swivel-out shoe cabinet with holder system for up to four pairs of shoes integrated in plinth of seat bench



Large queen-size bed

- + Unique: Pull-out TV wall and room divider for separating the washroom area, with TV in convenient, central position or at drivers side
- + Self-supporting head section
- + Two wardrobes at each side of the queen-size bed
- + Two large drawers at the front of the queen-size bed



Comfort corner kitchen

- + Raised kitchen work surface with designer bar cabinet as visual room divider and additional work surface
- + Six large drawers and separate waste container in separate hygiene area
- + "Profi Gourmet" 3-ring hob with divided glass cover, robust cast iron trivet and easy-clean glass base
- + 153 l fridge with door opening at both sides and separate freezer compartment
- + Pull-out system for capsule coffee maker at side of designer bar cabinet for convenient access (optional)
- + Slide-out storage cabinet integrated in round wash-room wall



Comfort luxury washroom with changing room

- + Large washroom/toilet room
- + Shower opposite
- + Changing room separable from living area, sleeping area and toilet room via luxury washroom door with 3-way function thanks to washroom double door and pull-out TV wall and room divider

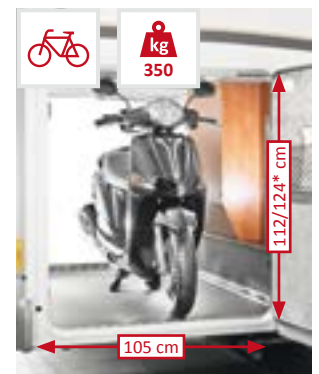

Chassis	Weight ready to drive	Payload up to	Seats with three-point seat belt	Berths
Fiat Ducato AL-KO Low frame 35 light	3,165 kg	1,595 kg	4/5*	2/3*

*with options



Pull-out system for capsule coffee maker (optional)



TV pull-out system behind backrest



Two large drawers at front of queen-size bed



Comfort corner kitchen with raised kitchen work surface with designer bar cabinet as visual room divider and additional work surface

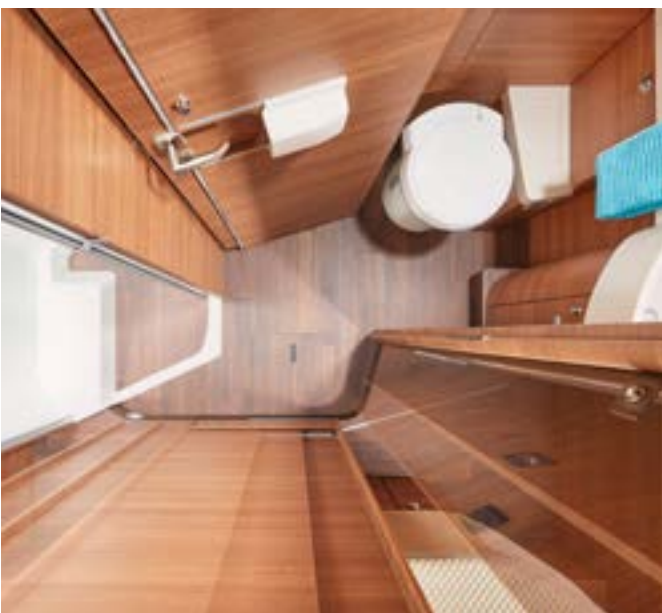

Comfort luxury washroom with changing room



Pull-out TV wall and room divider in central TV position

chic c-line new generation 2022

Exterior



AL-KO

Standard white

Main cabin, drivers cabin white, front, side, rear apron and wheel arches silver-platinum



Optional silverline

Main cabin, drivers cabin silver, front, side, rear apron and wheel arches silver platinum



Fiat Ducato front design (silverline, optional)



Fiat Ducato rear design (silverline, optional)

Subject to differences in colour combinations or individual colour shades, material quality differences and changes to the scope of delivery on the part of the manufacturer. This also applies to colour differences on basic vehicles, insofar as they are a result of changes made by the basic vehicle manufacturer.

Interior

chic c-line coachbuilt on Fiat Ducato with ivory part leather world of living



Optional: unique Carthago Pedelec scooter garage

For queen-size bed models – loading height extension to 124 cm.

Patented⁽¹⁾:
Pedelec scooter garage

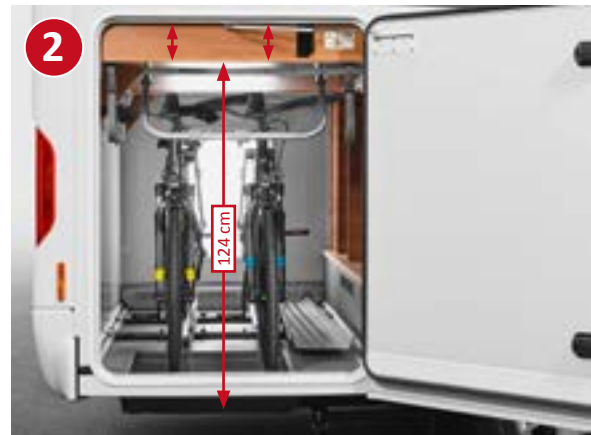

Your added value

- + Loading height extension of the Pedelec garage up to 124 cm in the queen-size bed models
- + Despite having a low bed access height, bicycles up to 124 cm in height can be transported in the scooter garage
- + Innovative solution with simple operation
- + Cover panel for floor recess, can also be used with a level garage floor





Usable height up to 70 cm

Double floor with huge storage compartment

EASY ENTRY – convenient loading from the outside, easy removal from the inside



Scooter garage with load capacity up to **350 kg**

PASSENGERS SIDE

Gas bottle compartment



Load from the outside

Convenient loading of the double floor storage compartment via a large external hatch (at the passengers side)



Unload from the inside

Easy removal of storage compartment contents from the inside via the lift-up side seat bench cover of the L-shaped lounge seating area



Additional double floor storage compartments

Living area floor hatch with double floor storage box (42 cm usable depth) in heated double floor

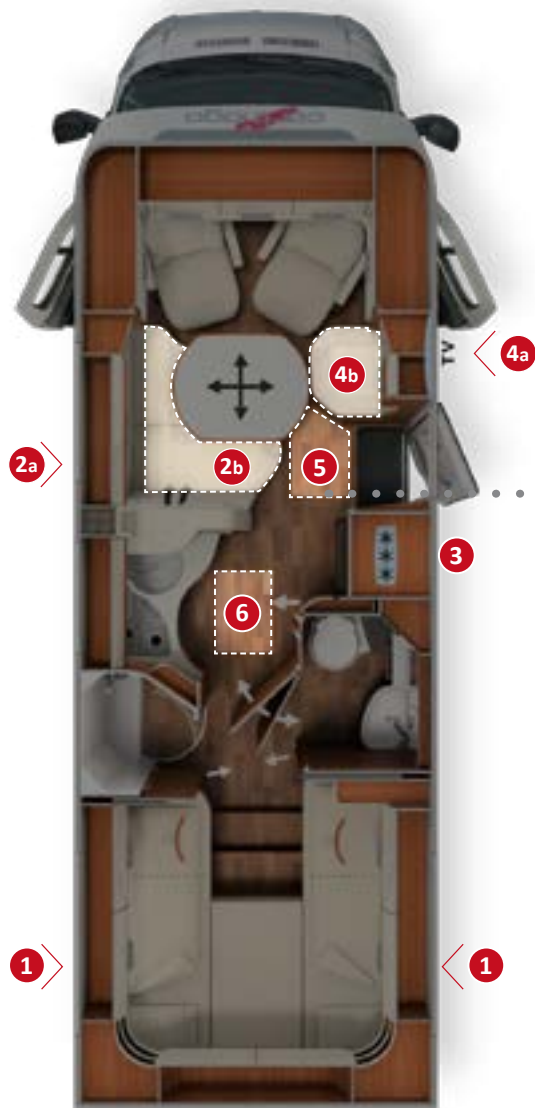



Your added value

- + **Double floor** with huge, heated storage compartment, usable height up to 70 cm
- + **Exterior access** via several large hatches
- + Convenient **interior access** via the L-shaped lounge seating area seat bench cover, hinged side seat bench and the large living area floor hatch
- + **Large, central through-loading space** (interior height 22 cm), with extra-low double floor storage compartment (usable height 46 cm), convenient loading through the habitation door via a large, self-supporting living area floor hatch
- + The entire double floor is heated with a **climate storage function** and underfloor heating effect



DRIVERS SIDE



Large, additional double floor storage compartment with separate external hatch (at the drivers side)



Convenient loading of the double floor storage compartment via a large external hatch

Load from the outside



Huge living area floor hatch in the entrance area: easy to load from the outside when habitation door is open







Convenient removal of contents via the hinged side seat bench

Unload from the inside

On-board equipment

Electrical equipment, water supply, warm air storage heating technology



- **Warm air storage heating technology**
Truma Combi 6
- **Optional:**
Alde warm water heating
- **Double floor**
with climate storage function and underfloor heating effect
- **Capacity**
170 l fresh water tank
140 l waste water tank
2 x 80 Ah gel battery



Truma Combi 6 warm air storage heating technology with numerous warm air outlets in the entire double floor, the living area, the scooter garage, the driver's cabin and in the cold-sensitive door entrances



"easy change" gas bottle compartment, extra-low for convenient bottle changing



Heated battery centre with main power switch. Standard: 2 x 80 Ah gel batteries, optional 90 Ah lithium-ion battery including battery computer and separate touch display



Electrical centre in scooter garage, easily accessible

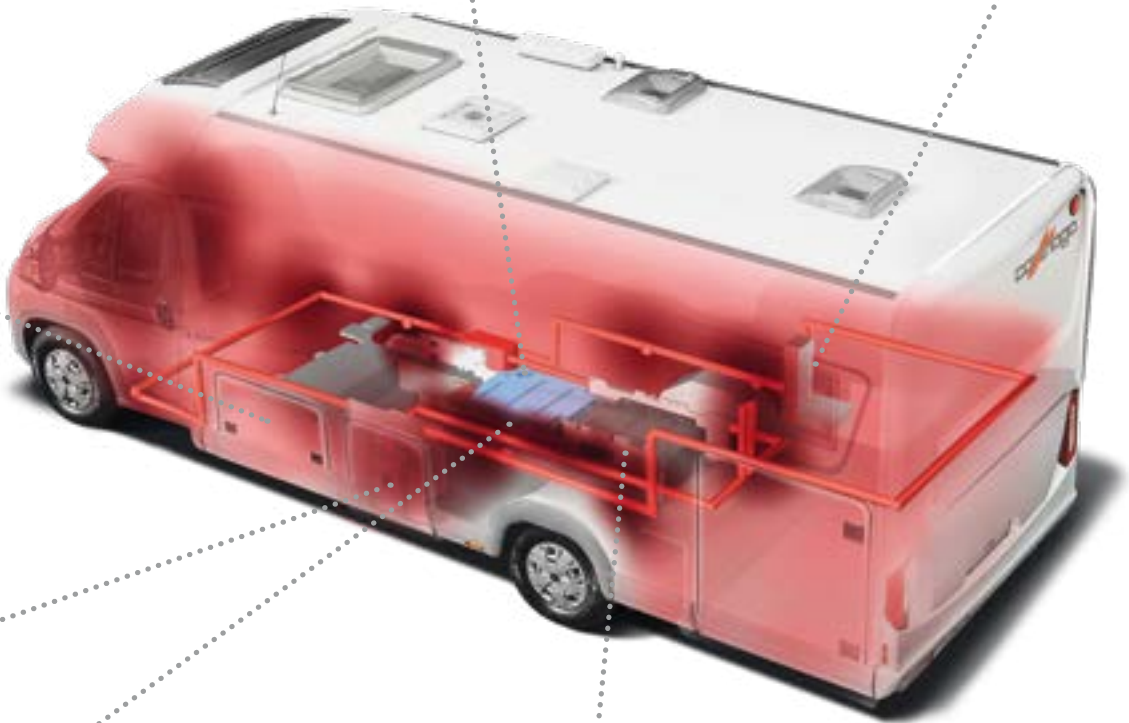

Water tanks protected from frost in heated double floor



Central water drain in the double floor – can also be operated from the outside through the habitation door



AL-KO low frame special light



Light weight, driving comfort comparable to a passenger car, fully galvanized

“coming home” function



With central locking: using hand transmitter in the main key for the drivers cabin doors and activating the exterior lighting

XL habitation door “premium two 2.0”



With widened passage size of 63 cm, secure double locking, extra-wide door window, pleated blackout blind and integrated Insect screen roller blind

Driver’s cabin pilot seats



With padded armrests at both sides, multiple adjusting facilities, headroom at lounge seating area level in living configuration

Single level living area floor



Continuous from driver’s cabin to the sleeping area

Swivel-out shoe cabinet



In the L-shaped lounge seating area in the entrance area with shoe holding system for up to four pairs of shoes

Exclusive lighting concept in LED lighting technology



With dimming function, main light with numerous spotlights and indirect ambient light, separately controllable

360° living area table



Can be moved in two directions and rotated by 360° using the foot pedal for optimal integration of all seats

Ergonomically shaped seat upholstery



With multi-layer premium foam core and stylish front panel

Profi-Gourmet cooker



With 3 hobs, easy-clean glass top, cast iron trivet and divided glass cover

Slide-out storage cabinet



Practical storage space with convenient access at hand height (T 4.8 LE room height)

Carawinx sleeping system



Medically recommended, point elastic under springing system and 7-zone quality cold foam mattress

Worlds of living

Large selection – the new upholstery collections from Carthago

	Collection	c-tourer		chic c-line		
	World of style	epic	Casablanca	linea moderna	linea classica	linea progressiva
Antara material	Barcelona 21	●	●	●	●	●
	Venezia 21	●	●	●	●	●
	Cambridge	●	●	-	-	-
	Rome	●	●	-	-	-
Textile leather / fabric	Malaga 21	○	○	○	○	○
	Davos	○	○	○	○	○
	San Remo	○	○	○	○	-
	Stockholm	○	○	○	○	○
Part leather	Ivory part leather	○	○	○	○	○
	Macchiato part leather	○	○	○	○	○
	Ivory Supreme part leather	-	-	○	○	○
	Sand Supreme part leather	-	-	○	○	○
Leather	Ivory leather 21	○	○	○	○	○
	Sand leather 21	○	-	○	○	○
	Macchiato leather 21	○	○	○	○	○

● Standard equipment ○ optional equipment - not available depending on model

Your added value

- + **Highly effective stain protection**
Fluids do not penetrate into the fabric. The majority of stains can be easily wiped off with a damp cloth.
- + **Excellent anti-fade properties**
- + **Hard-wearing and easy to look after**
- + **Washable curtains and decorative cushion covers**
- + **Antibacterial mattress cover**



Highly effective stain protection systems protect your upholstery

Upholstery design

c-tourer coachbuilt



The seating areas of the c-tourer T model series emanate sporty lightness with their dynamic contrasting inserts. This is emphasised by the modern double-stitched seams, which underline our high quality feel. These double-stitched seams are in a contrasting colour in the “Sand leather 21” and “Macchiato leather 21” collections. In the “Malaga 21” collection, elegant contrasts are provided by piping.

chic c-line coachbuilt



The seating areas of the chic c-line T model series create an elegant living room atmosphere. Piping or high-quality double-stitched seams are used as style elements at the edges of the upholstery. In the Sand leather 21 and Macchiato leather 21 collections, these double-stitched seams are in a contrasting colour and combined with piping in the same colour. In the “Malaga 21” collection, contrast is provided by piping and an additional stripe. Our “Part leather supreme” collections combine the most sophisticated materials from well-known Hitex® manufacturer “Rohleder” with fine leather. For high-end premium leather options in our vehicles, we have the “Performance” collections, which impress in the manufacturing style with their elaborately quilted leather inserts.

Worlds of living*

Very high quality Antara / fabric combination:

Antara with highly effective "Teflon Repel" stain protection, contrasting fabric with dirt-repellent stain protection

Barcelona 21



Venezia 21



Cambridge



Rom



Very high quality textile leather / fabric combination:

extremely hard-wearing textile leather in soft Nappa quality, contrasting fabric with dirt-repellent stain protection

Malaga 21



Davos



San Remo



Stockholm

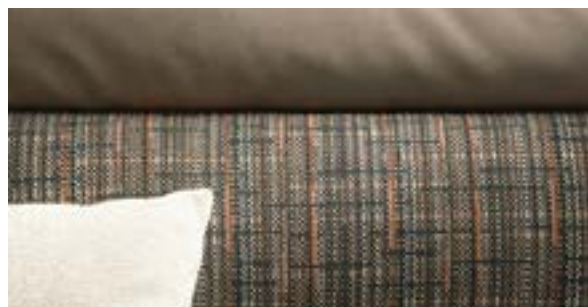

Very high quality leather / fabric combination:

leather with outstanding quality, contrasting fabric with dirt-repellent stain protection

Ivory part leather



Macchiato part leather



Ivory part leather supreme

ROHLEDER
DIE HITEX MANUFAKTUR



Sand Supreme part leather

ROHLEDER
DIE HITEX MANUFAKTUR



Very high quality leather finish:

classy combination of leather with outstanding quality

Ivory leather 21



Sand leather 21



Macchiato leather 21



The Carthago Premium DNA

More than a good feeling

Innovative thinking, an eye for detail, extravagant solutions and consistent development focus on a high degree of practical use, the perfect combination of **high-tech lightweight construction materials**, intelligent processing and **pioneering spirit**: these are the ingredients for our unique overall vehicle concept.

They are deeply rooted in our **Carthago Premium DNA**. It is an incentive and an obligation at the same time: The Carthago Premium DNA is our value promise to each Carthago customer, and brings together that which characterises every one of our motorhomes. And at the same time, it is an expression of that which makes Carthago different from other motorhomes. Our core expertise is in motorhomes in the liner premium

class. This is because our **40 years of experience** in this area flow into every stage of development and manufacturing. We think that only the best is good enough for your comfort and your safety! The materials and construction technologies that we use and the demands that are made of their weight and stability have many similarities to aviation technology.

In this way we can offer you a high degree of durability and value retention, safety, protection and comfort. This makes each Carthago motorhome something special, and therefore a **synonym for exclusivity and quality**. Or, to put it simply, Carthago stands for "The Motorhome".



Long-lasting. High stability.

Carthago Liner premium-class body construction

Space guaranteed.

Carthago double floor with huge storage compartment

Well-balanced. Optimum distribution.

Carthago payload & weight and balance



Well-being – all year round.

Carthago heating & air conditioning technology

Unique. Unmistakable.
Extravagant.

Carthago Personality

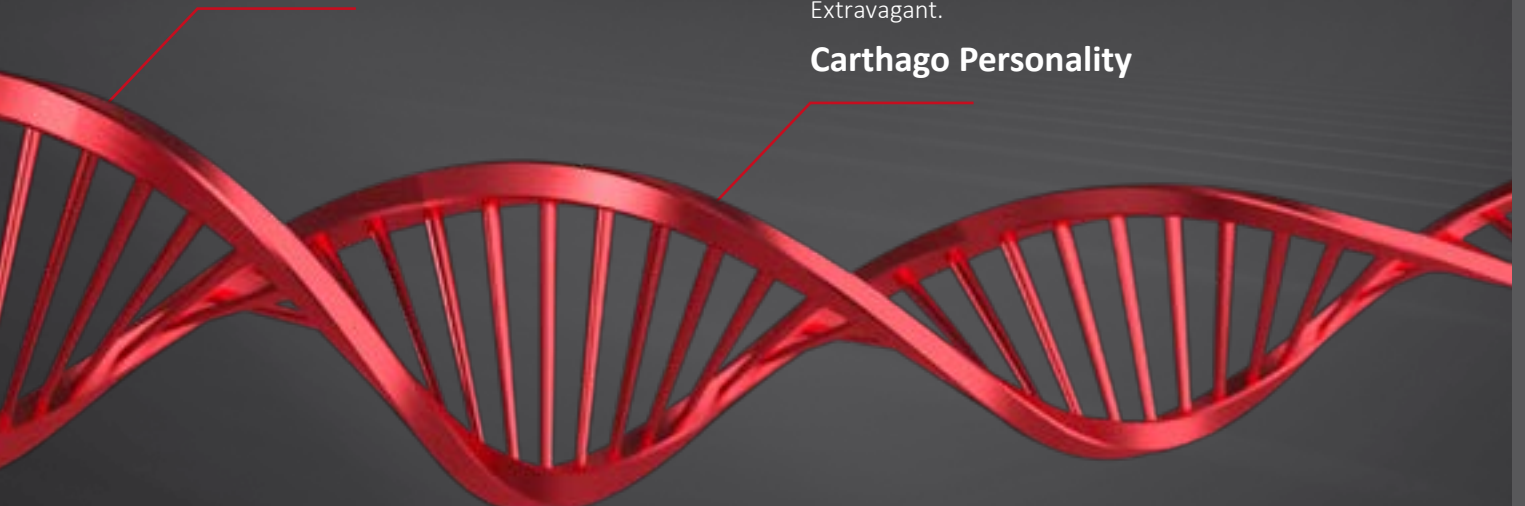

Liner premium-class body construction

Advanced technology inspired by aircraft construction

Carthago bodies have strong and durable connections. Where others use screw connections, we apply high-tech. As well as a high degree of stability, a main body reinforced with **frame members** and **special bonding technologies** also provides a clear advantage with regard to safety.

The frame member for connecting the floor and the side walls acts as **side collision protection** if the worst comes to the worst. Thanks to features inspired by aircraft construction, the main cabin is not only highly stable, but also light and torsionally rigid.

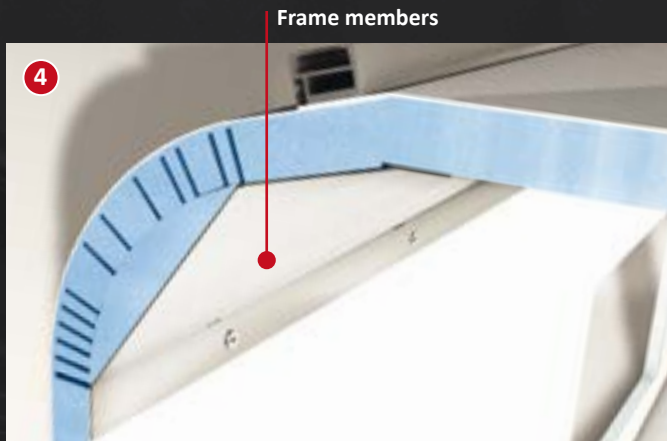

Carthago roof/wall connection

The typical Carthago curved roof is not only an unmistakable design element but with the frame members on the inside, it makes a decisive contribution to the rigidity of the main body. And all of this without any thermal bridges whatsoever. Another safety plus: less sensitivity to side wind.

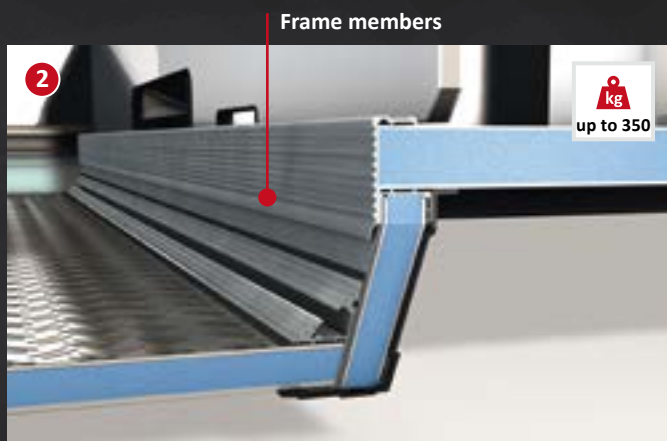

Carthago low-level scooter garage

Deep lowering of the scooter garage means maximum storage space and minimal effort when loading. An extremely strong wall to floor connection due to form-fitted and bonded frame members provides a load-bearing capacity of up to 350 kg.

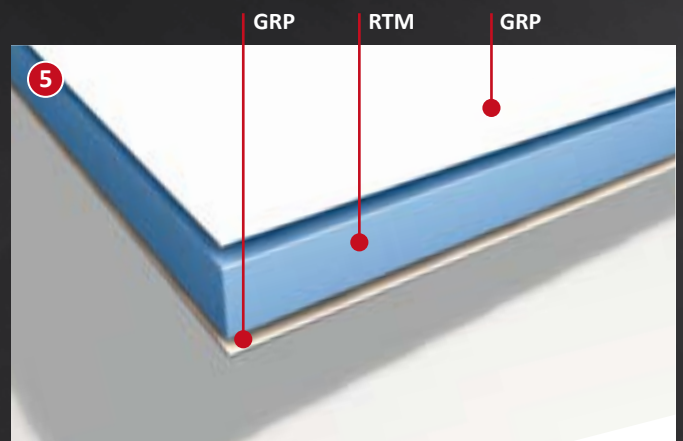

Carthago floor panel

Provides all-round protection. The lower and upper sides are made from GRP, and between them there is a hard foam insulating core made from RTM Styrofoam. The high-stability floor plate has a lifelong protection against humidity and rotting.



Your added value

- + **Body connection with high-stability frame members**
- + **Durability and value retention**
for many years
- + **Perfect insulation and heat storage**
for year-round comfort
- + **Maximum body stability**
and torsional rigidity, the decisive contribution
to ride comfort and driving safety
- + **Light vehicle weight**
due to self-supporting body design
- + **100 percent wood-free body,**
no rotting possible – also over the long term

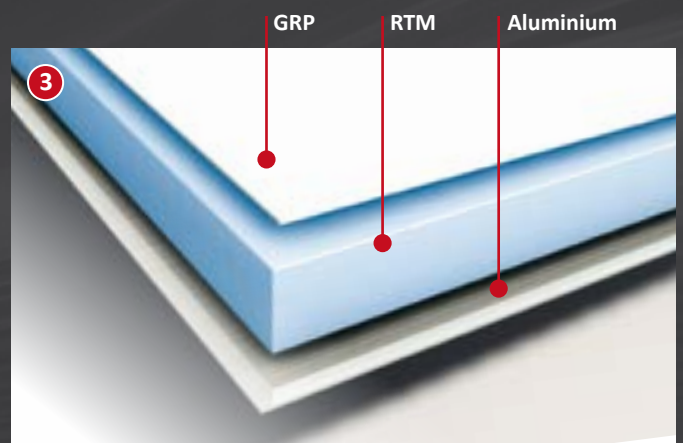

Carthago roof structure

Having GRP on the exterior means protection from hail, and having aluminium on the interior means protection against lightning strikes. The aluminium interior also takes over the function of heat storage in winter.

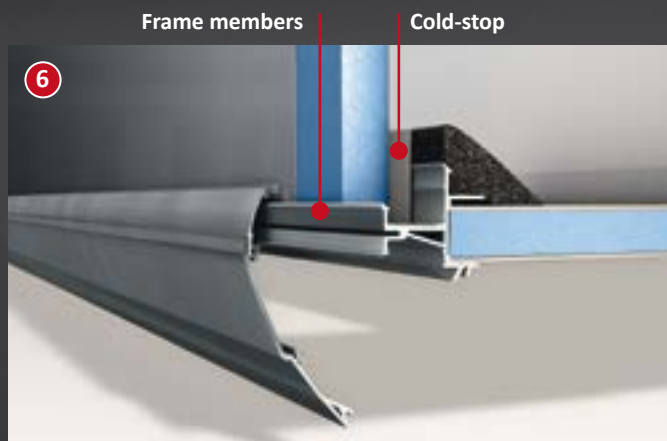

Carthago floor/wall connection

Provided at both sides via a high-stability frame member. Similarly to aircraft construction, it is form-fitted and bonded along the entire length. And if the worst comes to the worst, it has the effect of side collision protection. An integrated thermal bridge stop reliably prevents any thermal bridges.

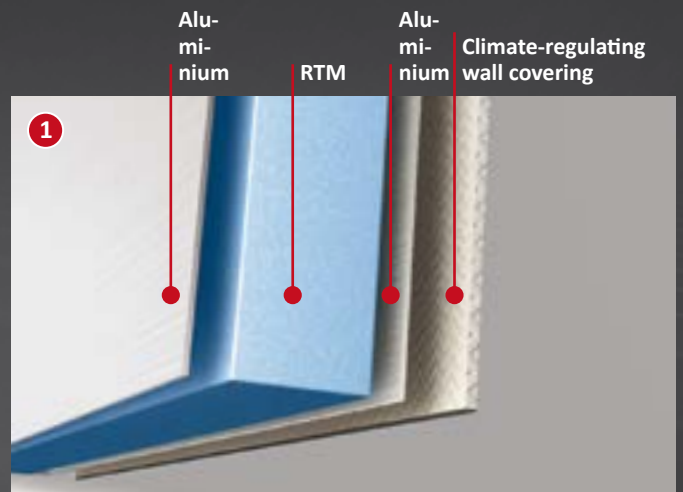

Carthago side wall construction

Having aluminium not just on the exterior but also the interior of the walls is a prerequisite for efficient heat storage. This produces the typical Carthago well-being climate. The homogeneous heat radiation acts like a wall heater.

Liner premium-class body construction

Longevity, protection and value retention

The Carthago body construction consistently orients itself to what Carthago drivers desire: long-term carefree driving and value retention. We therefore rely on **long term quality**. GRP and aluminium are used where they are most effective. For your protection and comfort, even in the event of hail, mois-

ture, lightning and cold conditions. The unique chassis connection via **extremely stable frame members** is the guarantee of maximum torsional rigidity. Quality that you can feel – journey after journey, year after year.

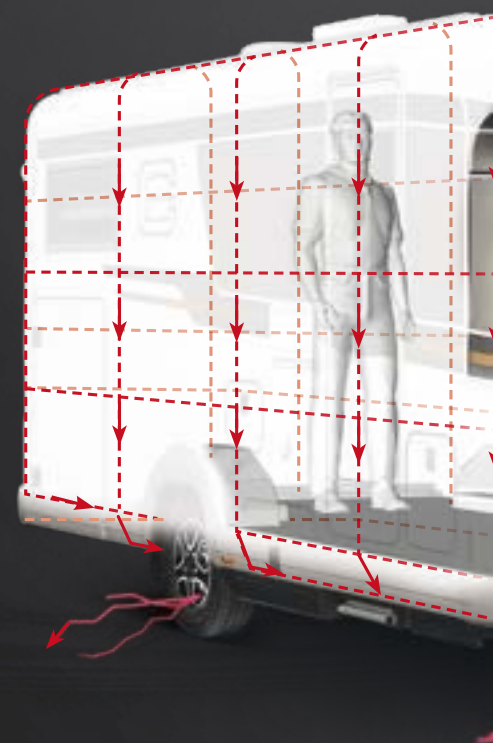
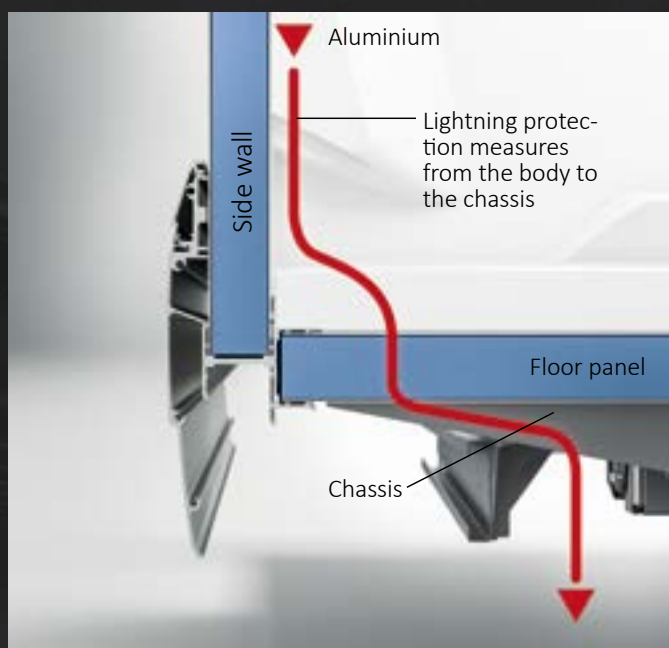

Tested lightning protection

Aluminium on the roof and the inner walls provides protection like a Faraday cage. Additional lightning conductors in the chassis significantly increase this protection effect. The lightning protection test has been proven: a Carthago main cabin provides verified protection against lightning strikes!



Lightning penetration

with conventional GRP roof with wood/GRP roof interior.



Your added value

- + Tested lightning protection
- + Protection from hailstones and moisture
- + 10-year warranty against leaks
- + Easy to repair in the event of damage
- + Stone chipping and underfloor protection

Hail protection

thanks to top side of roof made from GRP. This makes your insurance premiums cheaper. The special feature: The protection against lightning strikes is retained thanks to the aluminium on the inside of the roof.



Moisture protection

thanks to top side of roof made from GRP.



Stone chipping protection / underride guard

The GRP floor underside provides long-term protection against damage caused by stone impacts, rotting and moisture. For years – without the need for maintenance! The lowered frame of the scooter garage simultaneously acts as an underride guard and reduces collision damage.



Ease of repair

Wherever possible, attention is paid to segmentation during the development of the main body components. In event of damage, this makes replacement easier and saves money. For example, there is a separately replaceable rear bumper at the rear of every vehicle.

Double floor with huge storage compartment

More room for your holiday

You can never have enough storage space in a motorhome! The Carthago coachbuilt motorhomes provide a huge amount of storage space and room for your entire holiday luggage due to the unique double floor and many easily accessible storage compartments.

Bulky luggage such as camping furniture and skis can be stowed away in an optimum way in the central through-loading storage compartment.

The double floor can easily be loaded from the outside via numerous large exterior hatches.

Large self-supporting living area floor hatches provide access to the extra-deep storage compartments in the living and kitchen areas.

The double floor also acts as insulation, protecting your cargo from frost.

Your added value

- + **Biggest storage compartment in its class**
- + **Unique, huge double floor**
- + **Convenient exterior and interior access "EASY ENTRY"** load from the outside, unload from the inside
- + **Extra-deep storage compartments for additional usable height**
- + **Lowered storage compartment elaborately manufactured in original bodywork sandwich**, therefore maximum stability and high-efficiency insulation
- + **Fully usable storage compartment volume**, no restrictions caused by the installation of technical components
- + **Weight and balance - weight optimisation** and additional payload thanks to maximum usable axle loads and balanced weight distribution between front and rear axle



Approx. 1,280 l double floor storage compartment!

(on the example of the chic c-line l 4.9 LE)

Like the A-Class models, the coachbuilt versions also have a unique double floor with a huge storage compartment

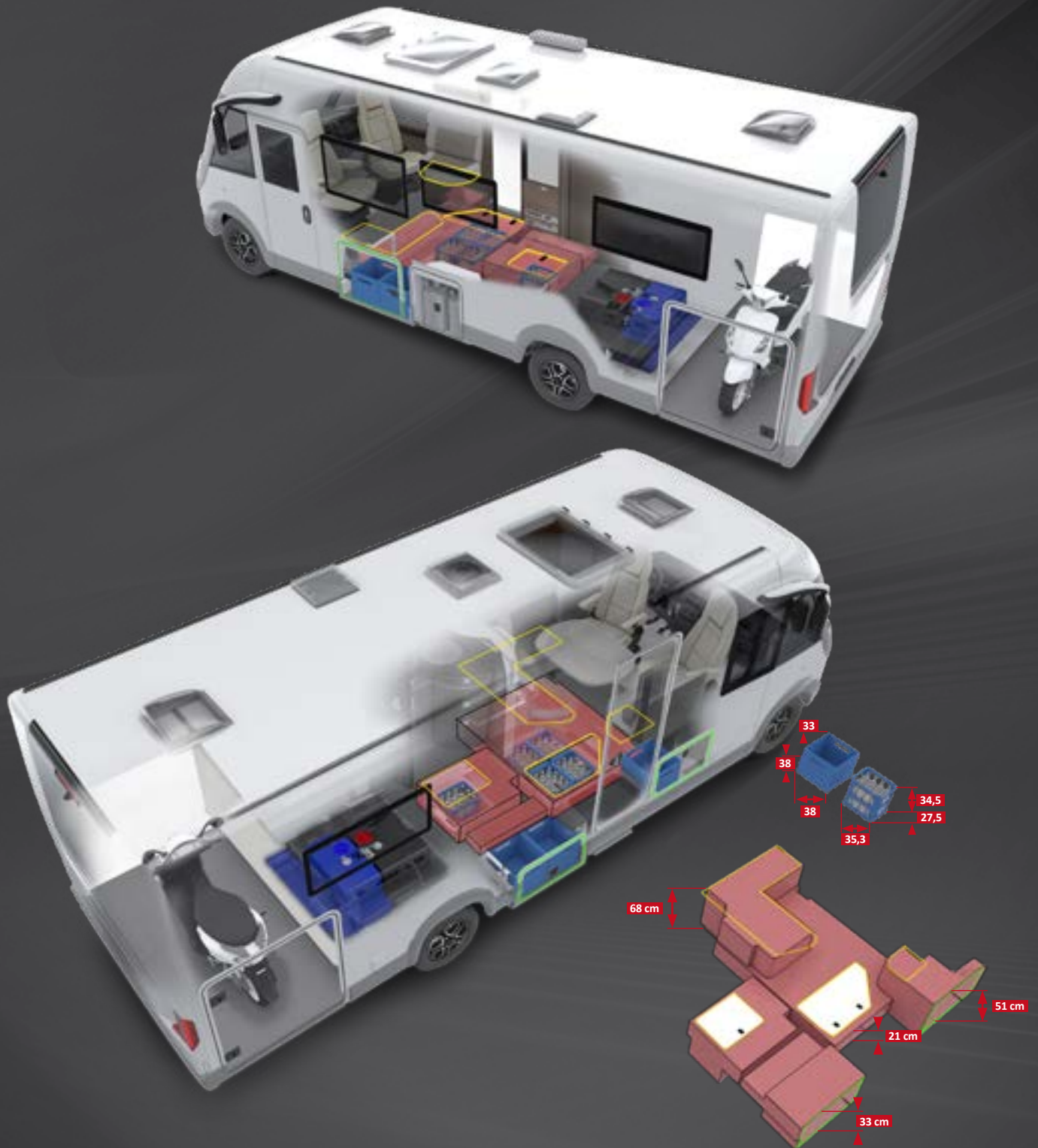

- Double floor with access via interior and exterior hatches (volume approx. 1,280 litres)
- Access to double floor via exterior hatch
- Access to double floor from the inside (seat bench and floor hatches)

Double floor with huge storage compartment

EASY ENTRY – convenient loading from the outside, easy removal from the inside



Gas bottle compartment



Scooter garage, load capacity up to **350 kg**

Scooter garage with considerable interior height thanks to deep lowering, accessible at both sides via a large door at the passengers side and a second door at the drivers side

Load from the outside



Convenient loading of the double floor storage compartment via a large external hatch

Unload from the inside



Easy removal of storage compartment contents from the inside via the lift-up seat bench cover of the L-shaped lounge seating area

Additional double floor storage compartments



Living area floor hatch with double floor storage box (42 cm usable depth) in heated double floor

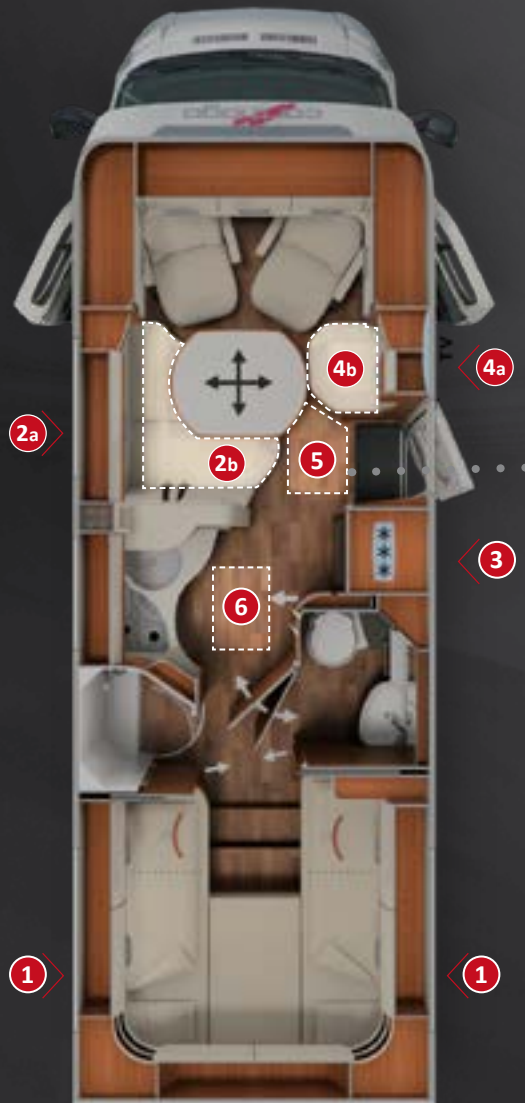



Your added value

- + **Double floor** with huge, heated storage compartment, usable height up to 70 cm
- + **Access from the exterior** via several large hatches
- + **Access from the interior** via the L-shaped lounge seating area seat bench cover, the lift-up side seat bench and the large living area floor hatch
- + **Large, central through-loading space** (interior height 22 cm), with extra-low double floor storage compartment (usable height 46 cm), convenient loading also from the outside through the entrance door via a large living area floor hatch
- + **Climate storage function:** The entire double floor is heated with an underfloor heating effect



Usable height up to 70 cm



Large, additional double floor storage compartment with separate exterior hatch



Convenient loading of the double floor storage compartment via a large external hatch

Loadable from the outside



Huge living area floor hatch in the entrance area: easy to load from the outside when main cabin door is open

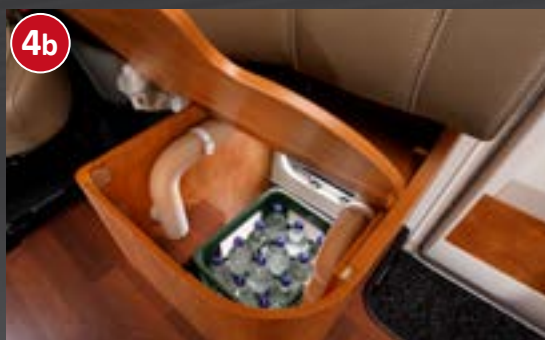

Convenient removal of contents via the hinged side seat bench

Unload from the inside

Carthago Pedelec scooter garage

The garage wonder for queen-size bed models with an interior loading height extension of up to 124 cm

Will your big bike or Pedelec not fit into the rear garage of your motorhome?

Not a problem with Carthago's queen-size bed models. This is how it's done: Just swivel up the rear bed from the outside **with a single manual operation**, park the bike in the garage, **lower the rear bed again**. The Carthago trick:

a recess in the floor accommodates the bike. Securely lash everything – done in an instant and handlebar heights of up to 124 cm are possible in combination with the swing-up bottom edge of the bed. In spite of this, the bed is easily accessible from the inside at any time thanks to the low position. Just another one of the many great Carthago ideas. And because it's so good, we've **registered it for patent approval.** ⁽¹⁾



Pedelec scooter garage

Available with the model series with queen-size beds



Easy loading

of a Pedelec using the push-in system with the hook-on drive-in ramp



Your added value

- + **Patented⁽¹⁾: Carthago Pedelec scooter garage**
- + **Interior height extension**
of the Pedelec garage to up to 124 cm in the queen-size bed models
- + **In spite of low bed access**
Bikes with handlebar height of up to 124 cm can be transported in the rear garage, no unloading required in order to sleep
- + **Innovative solution**
with simple operation
- + **Cover plate for floor recess**
can therefore also be used as an additional storage compartment with a level garage floor



Loading height extension
by simply swivelling up the interior rear bed with one hand and the additional lowered floor recess

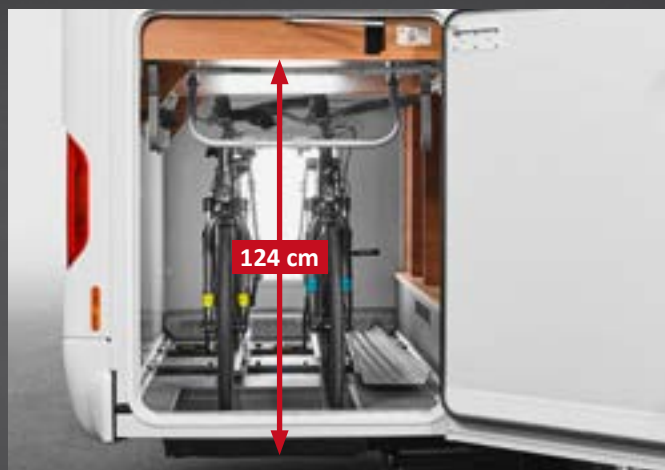

Handlebar height of up to 124 cm is therefore possible

Carthago payload & weight and balance

Travel in comfort and safety with a heavy payload

No fear of the scales: a Carthago has reserves, even for large luggage items! You will find a heavy payload in the construction specification of every new Carthago. Because it represents the basis of a high degree of comfort and safety on your travels. It is a natural constituent of the Carthago Premium DNA. A harmonious weight balance is a matter of course for a Carthago. Two or even three-axle load-bearing chassis represent the basis. Clever wheelbases ensure that the weight distribution is favourable, utilise the maximum axle loads and lead to a safe and confident driving style at the same time.

Intelligent lightweight construction technology reduces the weight of the vehicle. Finally, the numerous gross vehicle weight variants ensure that you have exactly the payload that is individually required. Carthago also means not having to forego anything with regard to payload, since holidaymakers do not have to restrict themselves, even on long trips: you can simply take your favourite things from clothing to Pedelecs with you in the huge storage compartments. And a Carthago also always has sufficient reserves for taking souvenirs from the vineyard or the fashion store home from your holiday.

Maximum payload reserves – balanced out in the best possible way*

(on the example of the c-tourer T 143 LE)



*Payload reserves per axle depending on the vehicle configuration



Your added value

- + **Travel comfort**
no restrictions as far as holiday luggage is concerned, and optimum utilisation of the potentially record-breaking storage compartments in the Carthago motorhome
- + **Weight and balance - weight optimisation**
additional payload due to balanced weight distribution between front and rear axle
- + **Numerous individual weight variants**
result in individual reserves for each model and each configuration
- + **Maximum safety on the road**
no risk due to overloading and over-stressed components, safe driving style



The Carthago double floor

Together with the high-stability self-supporting main body construction, it contributes to providing a high degree of stability and torsional rigidity, and is extremely lightweight at the same time. A "special light" AL-KO low frame is used exclusively for the lightweight models. Result: minimal vehicle weight – maximum payload.



Balanced weight distribution

Large storage compartments and sufficient payload alone are not enough. Carthago uses wheelbases which are coordinated in a model-specific way. The result is an optimum weight balance between the front and rear axle – the prerequisite for practical use of the storage space.

Press opinions

„The generous double floor not only holds storage space, but is also heated. [...] It has: primarily sufficient storage space for containing a couple’s entire household contents. This is not only made possible by the clever conception and division of the storage compartments in the interior, but also by the heated double floor, which is easily accessible from inside and outside, and the spacious rear garage.“

AutoBild Reisemobil, 04/2021,
c-tourer T 143 LE travel report

“With the chic c-line T 4.9, Carthago is showing that the low profile is also good for mobile luxury, as well as for the entry level and middle classes. Heated double floor, large garage and plentiful amount of room are standard in this vehicle. The vehicle design is stylistically unique at Carthago.“

Reisemobil International, 09/2017,
Comparison test of chic c-line T 4.9 LE

Carthago heating and air conditioning technology

Cosy and comfortable, just like at home

We can't think of any reason why you should have to forego a good climate, regardless of where you are travelling to, and when. For this reason, a Carthago provides year-round comfort thanks to technical refinements such as heat-reflecting walls, targeted heating of the on-board equipment and heat

circulation throughout the double floor. This provides the best conditions for a **real well-being climate during both summer and winter**. Because that which insulates and keeps the heat in during the winter also keeps you cool during the summer.

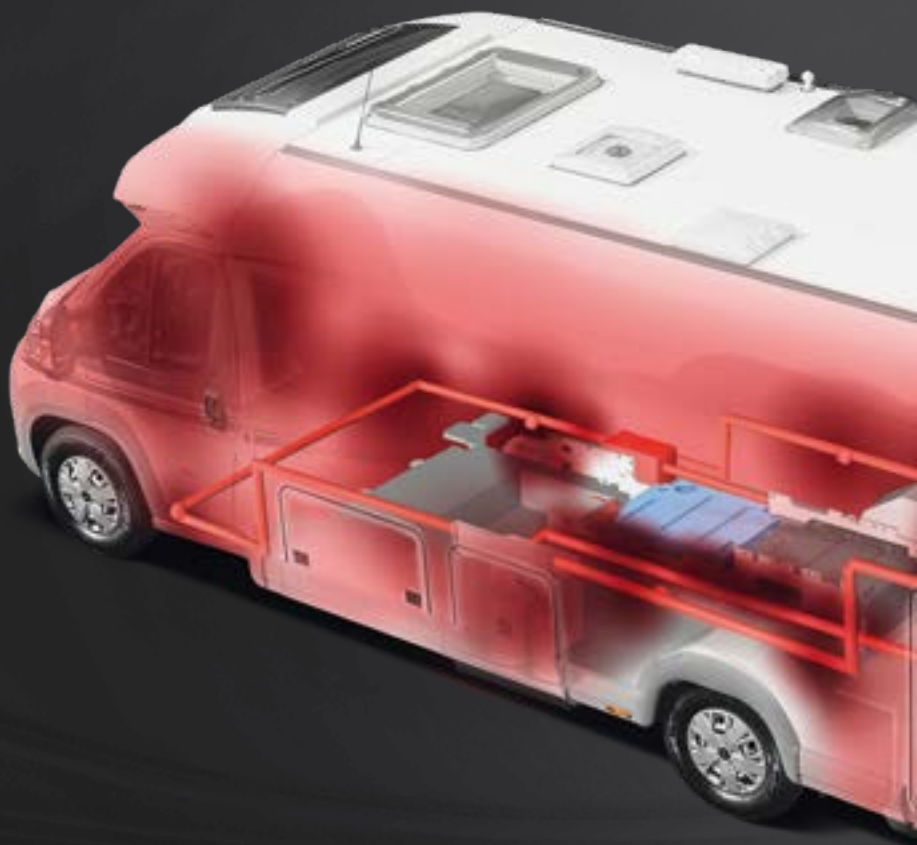

Truma Combi 6 warm air storage heating system with numerous warm air outlets in the entire double floor, the living area, the scooter garage, the driver's cabin and the cold-sensitive door entrances.



Carthago underfloor heating effect
Numerous hot air outlets and heat circulation channels in the double floor ensure that the heat is evenly distributed. This heat accumulation radiates upwards towards the floor of the living area and gives it a pleasant warmth. You always have warm feet in a Carthago.



Your added value

- + **Aluminium interior walls**
= 1,000 times better heat distribution than traditional wooden interior walls
- + **Winter-proof motorhome**
with year-round comfort
- + **Underfloor heating effect** –
your feet are always warm
- + **No warm air draughts**
thanks to cold stop at critical points
- + **Even heat distribution**
and radiation due to the aluminium inner wall
- + **Heat storage effect**
and efficient insulation reduce gas consumption
- + **Targeted heating**
of all technology components safeguards functionality



Heated technical components

Heating is a standard feature in a motorhome. So is the fact that it heats the living area. Areas which are sensitive to cold are provided with targeted heating in a Carthago motorhome: all technical components such as tanks, batteries, storage compartments, doorways, etc. This is the guarantee of full functionality, even at low minus temperatures.



Carthago wall heater effect

Aluminium that is also on the insides of the walls stores the heat that is absorbed and evenly gives it off again. This results in a very pleasant wall heater effect. Aluminium conducts heat 1,000 times better than conventional inside walls made from timber.

Carthago Personality

Distinctive, unmistakable, unique: a Carthago is THE face in the crowd. It is as individual as its owner. The evolutionary Carthago design sets standards that go beyond the motorhome industry. **Shape and function** combined into a perfect symbiosis. Powerful radiator grille and elegant cab pod, stylishly rounded transition from the side walls to the roof, offset sills and a sturdy rear – together with the subtle

décor, this all combines to produce the typical Carthago look with harmonious shapes and flowing lines. **Every detail is well thought-out.** The main cabin window and hatches are flush-mounted in the side walls. Even the filler cap of the coachbuilt motorhome is flush-mounted. The rear lights form the end of the vehicle – with Carthago C-branding in LEDs.



The Carthago curved roof a Carthago awakens emotions because of its independent and elegant design such as the curved roof that is typical of the brand. It also increases the torsion resistance of the body, and there is less susceptibility to side wind. The perfect combination of design and practicality!



Carthago front pod combines elegant design and high quality GRP construction. Thanks to the two shell insulation, the Carthago coachbuilt motorhomes guarantee the best living climate, even at low temperatures.



The Carthago front design represents uniqueness, connects and is immediately recognisable on the roads. The well shaped radiator grille emphasises the dynamics of the entire motorhome.



Workmanship quality: furniture from our own joinery, manufactured and fitted piece by piece with meticulous craftsmanship – nothing wobbles or rattles. It is no coincidence that Carthago always achieves the best results for its outstanding processing quality. Carthago furniture design is a quality feature that is mentioned again and again. Thanks to the double connection technology, highly stable and designed for a long life.



Your added value



- + **Striking and individual design concept**
- + **Elegance and dynamics**
due to the three-dimensional shapes and curves
- + **Flat bodywork surfaces**
due to invisibly recessed hinges and flush-mounted integrated tank flap
- + **Furniture made in our own Carthago joinery**
- + **Stable “Durafix” double connection technology**
screwed in place and mortised
- + **No creaking or rattling while driving**
noise reduction by means of anti-knocking cushioning
- + **Stay, hinges and drawers**
with solid household quality
- + **Seating comfort on long journeys**
thanks to the ergonomically shaped quality upholstery
- + **Indirect lighting with LED lighting technology**
for a cosy atmosphere



LED lighting technology: Bright reading light or cosy ambient lighting – made possible by the Carthago LED lighting technology. Numerous spotlights in the right locations and effective indirect lighting in appropriate locations provide impressive effects. And this is also power-saving and long-lasting.

Our powerful partners

Top class partners for top class quality

A top chef only uses the best ingredients for a first class menu. Only selected components are also used for top class motorhomes. We have chosen strong partners for your Carthago - strong in performances, strong in quality and strong in service. So that you can enjoy your holiday

in a Carthago in a relaxing way, just like you would enjoy a Michelin-starred menu. Would you like to upgrade your Carthago into your own personal travel dream? If so, we recommend having your original Carthago accessories factory-installed.



Aguti
www.aguti.com



Aguti seats are multi-talented with regard to comfort, safety and ergonomics. They are specially tailored to the requirements of motorhomes, and fulfil all travelling and living requirements. The seats are guaranteed to provide healthy seating that supports your body, thanks to the anatomically adapted contact surfaces for the legs and back.



Alois Kober GmbH
www.alko-tech.com



Carthago puts its trust in innovative AL-KO technology such as the AMC chassis with torsion bar suspension and individual wheel suspension for more comfort and safety and also the high-strength and hot-dip galvanised AL-KO lightweight construction technology for more storage space and more payload. But also the innovative and modern hydraulic supports and pneumatic suspension systems with intuitive operation.

alphatronics

alphatronics – Size in detail

www.alphatronics.de



All of the televisions in your Carthago motorhome are manufactured by alphatronics in Nuremberg. This ensures that you get consistently high quality, so that all your expectations of a reliable motorhome television are fulfilled. The “Made in Germany” quality claim is not only manifested during the manufacture of the devices, but starts during development. The company is always at the cutting edge due to having its own development department, and has been impressing its customers for years with innovations for mobile use.



DOMETIC

www.dometic.com



DOMETIC 10 series – keep it fresh, keep it cool. The new 10 series by Dometic has completely redefined the standards for mobile refrigerators: double sided door stop for access from both sides, aluminium handles over the entire height of the fridge, intuitive control with TFT display and the best cooling power in this class!



Super B

www.super-b.com



Super B supplies the lithium batteries for Carthago. These high-end lithium batteries provide tremendous energy reserves and are much lighter, easy to install and have a considerably longer shelf life than other batteries. The Epsilon battery was specially developed for use in motorhomes. Due to the company’s own intelligent battery management (BMS) and Bluetooth functionality, you are always kept informed about the current status of the battery and the amount of energy that is available. You will enjoy a high degree of self-sufficiency and optimum comfort on your trip with Carthago and Super B.



tegos GmbH & Co. KG
www.tegos-systeme.de



The new cabin door has redefined the standards in every respect: The high-quality door look blends in with the luxurious vehicle ambience with smart operating options with an RFID chip and coming home function and a smooth-running, electro-mechanical locking function provide security and comfort, with the exquisite combination of high-gloss chrome elements, elegant wooden decors, internal door hinges and the almost invisible insect screen system. Innovations and excellent quality which provide differentiation and added value, developed by Carthago and tegos as partners.



Teleco
www.telecogroup.com



The Teleco Group is one of Europe's leading companies in the camping accessories area. Teleco stands for quality products in the areas of satellite systems, televisions, air conditioning systems and generators. Particularly in satellite systems and televisions, the products excel because of their high quality, precision and innovative technology. More than 40 years of experience and a pan-European service network make Teleco a reliable partner. This is why Carthago puts its trust in its satellite systems.



Thule

www.thule.com



Travelling with your leisure vehicle means freedom: you can start whenever you want, and go wherever you want. You can stop in the most beautiful locations and enjoy living outdoors. A Thule awning is the perfect way to have a protected area next to your vehicle. Check out our smart blockers, tents, bike racks and much more!



**Truma Gerätetechnik
GmbH & Co. KG**

www.truma.com



Experience everything that nature has to offer outside, and enjoy the highest levels of comfort inside: Our Combi heaters and roof-mounted air conditioning systems turn your holiday into a carefree camping experience. The best example: the Truma Aventa comfort cools your motorhome extremely quickly and reliably with a powerful 2,400 W. The 800 or so Truma employees do their best every day to provide you with reliable premium products and excellent service.

This information is subject to design and equipment modifications and also errors. The details concerning scope of supply, appearance and performance correspond to the state of knowledge at the time of printing. If our suppliers change product designations during the season, we reserve the right to deliver a part type of equivalent value.

Carthago Reisemobilbau GmbH
www.carthago.com



Changes may occur during the model year after the editorial deadline for this printed document in July 2021. The manufacturer reserves the right to make structural and design changes that become necessary, provided they are in the interest of technical progress and are reasonable for the customer, plus changes to equipment, differences in colour combinations or individual colour shades, material quality differences and changes to the scope of delivery on the part of the manufacturer. This also applies to colour differences on basic vehicles, insofar as they are a result of changes made by the basic vehicle manufacturer. Please consult your dealer for detailed advice concerning the status of the current product or series.

The information about the scope of delivery, appearance, performance, dimensions and weights of the vehicles (differences within the scope of the factory tolerances ($\pm 5\%$ max.) are possible and permissible) corresponds to the state of knowledge at the time of going to print. Please be aware that some of the vehicles are depicted with special equipment for which an additional charge applies. In some cases they are shown with equipment features that do not correspond to the series production version and are also not available as special equipment. The decoration depicted in the catalogue is not a constituent of the scope of delivery. More technical information can be found in the price list.

Prior written consent from Carthago Reisemobilbau GmbH is required for the reprinting of this publication or extracts thereof. The information in this publication is compliant with the German StVO and StVZO (road traffic and road traffic licensing regulations). No liability accepted for errors and/or misprints.

¹⁾ Patents / patent registrations are model- and country-specific

© Carthago Reisemobilbau GmbH. 88326 Aulendorf, Tel. +49 7525 9200-0
Printed in Germany.

www.carthago.com